

lavenderconsulting

DISPLAY

Display solutions are one of the most popular and impactful visual communication media on the market.

Whether it is for frequent and regular use or for a durable fixed arrangement, a multitude of solutions exists and for any budget.

To successfully communicate your messages and brand at point of sale, shows and events it is essential to understand:

- The environment in which the display will be exhibited.
- Whether the display will be renewed and how frequently.
- The quality appropriate to the event and relative to the desired budget.
- How to accessorise the product to increase its functionality.
- It is essential to stand out from the competition with high-end, original solutions that distinguish your brand from the competition.

This comprehensive guide offers you a wide choice of products. We will help you find the best solution suited to your needs.

3

Roller Banners

15

Tension Banners

21

Flags

29

Outdoor

39

POS Signage

51

Counters

63

Backwalls

75

Modular Solutions

89

Literature Holders

93

Cases

97

Lighting

Symbols Key



1, 5 or Lifetime Guarantees for Product Hardware



New Product



Best Sellers



Product Comes with a Bag



Made in Europe



Dimensions

Guarantee

All products are covered by a manufacturer's guarantee against component failure and defects. Our premium banner range is covered by a lifetime guarantee, the rest of our range is covered by a five year guarantee with the exception of our Illuminated, Economy, Basics and Outdoor products which are covered by a one year guarantee. We are continually improving and modifying our product range and reserve the right to remove products or vary the specifications without prior notice. All dimensions state height first. All dimensions, graphic information and any weights quoted are approximate and should be used as a guide only. We accept no responsibility for variance. E&OE



1. Revolution
2. Original Banner+
3. Mosquito

Roller Banners

Simple, stunning, stylish – banners are still one of the most popular, effective and easy ways to promote your business and get your message across in a wide variety of environments.

With one of the most comprehensive ranges on the market, our banners are designed to suit every budget and fit all situations. From single to frequent use and multiple changing of graphics.

Roller Banners are one of the most popular and effective communication tools available.

Using our solutions will exceed your expectations, whatever your needs may be, from desktop, retail outlets, exhibition stands to the office environment.

We have one of the widest ranges of both economy and premium Roller Banners on the market, with widths ranging from 600mm to 3000mm! It's therefore important to choose the right one for your needs. Here is a quick guide explaining what you should consider.

When Choosing Your Roller Banner Ask Yourself:

1. Where will it be used? - Indoors or outdoors?
2. How often will your banner be used? - Occasionally or daily?
3. How much space is available for the banner?
4. What is the right size to attract your audience? - It's important to choose the right size without over-crowding your display area.
5. Will you need to change the graphic? - Will you keep a constant message or need to alternate messages for different occasions or offers?
6. What is the right material for your needs? - Check the environment and select the right materials to meet your needs - banner vinyl, polyester or textile fabric.
7. What is your budget? - Once determined you can choose the best quality that will suit your needs.

// Top Graphic Attachment

Banner graphic rails explained.



Snap Rail Premium Dual Action Self-adhesive and Snap Rail Self-adhesive Rail

// Spot Lights



Powerspot 800 LED Spot Light

// Base Graphic Attachment

Tip:
To update your graphic more easily, choose cassette or snap system



Self-adhesive Leader Sliding System Hook and Loop Strip Snap Cassette

// Transport Bag

Bags are provided for all roller banners, and include a label pocket and handles for ease of transportation



Simple Nylon Nylon Padded EVA Nylon with Padded Inner Protection (double skin) Padded Nylon with Side Opening and Foam Reinforcements on Sides

Premium



Easy to use, stylish cassette banner

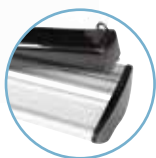

Change your display in seconds

Imagine+



- Cassette banner for quick change graphics
- Snap rail with end caps
- Adjustable feet and hybrid adjustable height telescopic pole
- Stylish black end covers
- Supports Linear accessories (See page 6)

Model	Code	↕ (h) x (w) x (d) mm
850 mm	UB502C-850A3	2220 x 910 x 215 mm
1000 mm	UB502C-1000A3	2220 x 1060 x 215 mm
850 mm cassette only	UB175-850	N/A
1000 mm cassette only	UB175-1000	N/A



Sleek pinstripe detailing at the front



Adjust the banner height from 1605mm up to 2210mm

Barracuda



- Strong and durable design
- Large internal graphic housing with tensioner
- Premium dual action self-adhesive and snap rail with secure end caps
- Hybrid adjustable height telescopic pole
- Stylish end covers
- Supports Linear accessories (See page 6)

Model	Code	↕ (h) x (w) x (d) mm
800 mm	WH321C-800A3	2210 x 860 x 200 mm
1000 mm	WH321C-1000A3	2210 x 1060 x 200 mm
1200 mm	WH321C-1200A3	2210 x 1260 x 200 mm
1500 mm	WH321C-1500A3	2210 x 1560 x 200 mm
2000 mm	WH321C-2000A3	2210 x 2060 x 200 mm
2400 mm	WH321C-2400A3	2210 x 2460 x 200 mm



Premium



Graphics are easily updated using the interchangeable cassettes



Sleek and elegant design



Merlin



- Snap rail with end caps
- Cassette banner with adhesive leader
- Replacement cassette sold separately
- Hybrid adjustable height telescopic pole and snap rail
- Adjustable feet
- Stylish black end covers



Change your display in seconds

Model	Code	↕ (h) x (w) x (d) mm
850 mm	UB160-850	2095 x 915 x 195 mm
1000 mm	UB160-1000	2095 x 1065 x 195 mm
850 mm cassette only	UB175-850	N/A
1000 mm cassette only	UB175-1000	N/A



Custom sizes available including Grand Format



Also available in grand format sizes

Original+



- Premium dual action self-adhesive and snap rail with secure end caps
- Self-adhesive sliding leader
- Hybrid adjustable height telescopic pole
- Adjustable feet
- Also available in black at an additional cost
- Linear accessory channel



Hybrid adjustable height telescopic pole

Model	Code	↕ (h) x (w) x (d) mm
600 mm	UB322-600C1	2095 x 640 x 195 mm
800 mm	UB322-800C1	2095 x 840 x 195 mm
850 mm	UB322-850C1	2095 x 890 x 195 mm
1000 mm	UB322-1000C1	2095 x 1040 x 195 mm
1200 mm	UB322-1200C1	2095 x 1240 x 195 mm
1500 mm	UB322-1500C1	2095 x 1540 x 195 mm
2000 mm	UB322-2000C1	2095 x 2040 x 195 mm
2400 mm	UB322-2400C1	2095 x 2440 x 195 mm
3000 mm	UB322-3000A1	2095 x 3040 x 195 mm



Premium dual action self-adhesive and Snap Rail

Increase Functionality with Linear Accessories

Choose from our optional accessories to make your banner multifunctional and more visible

Compatible with: Original+, Imagine+, Barracuda and Excaliber2 banners



Model	Code
Shelf post*	LNBA-02
Shelf	PBA-02
Acrylic leaflet holder post*	DL/A4/A5 LNBA-DLP
Acrylic leaflet holder in DL	AH5DLP
A4	AH5A4P
A5	AH5ASP
iPad/LCD Screen† mount*	LNBA-03
iPad holder* in black/white/silver	IPAD-HU-B/W/S
Steel leaflet holder	LNBA-01

* Shelf, leaflet holders, LCD screen/iPad mount, iPad and iPad holder are not included

† LCD Mount available on Excaliber2 banners only, max weight 5kg



Standard

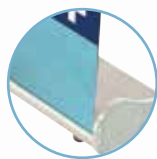

Front-entry graphic

Orient+



- Floor to rail visibility
- Premium dual action self-adhesive and snap rail with secure end caps
- Hybrid adjustable height telescopic pole
- Adjustable feet

- Model 1200 mm and above sizes comes with two poles

Model	Code	↕ (h) x (w) x (d) mm
800 mm	WH353-800-003	2170 x 840 x 185 mm
1000 mm	WH353-1000-003	2170 x 1040 x 185 mm
1200 mm	WH353-1200-003	2170 x 1240 x 185 mm
1500 mm	WH353-1500-003	2170 x 1540 x 185 mm
2000 mm	WH353-2000-003	2170 x 2040 x 185 mm



Premium dual action self-adhesive and Snap Rail



Optional Hook and Loop Strip

Also available in Grand Format



Snap roller

Avant



- Snap rail with end caps
- Snap roller instead of self-adhesive leader
- Hybrid adjustable height telescopic pole
- Top opening to gain access to the snap roller
- Single, rear twist-out foot
- Chrome finish end covers

- Fabric graphic not recommended

Model	Code	↕ (h) x (w) x (d) mm
850 mm	UB400-850	2080 x 890 x 240 mm
1000 mm	UB400-1000	2080 x 1040 x 240 mm



Hybrid adjustable height telescopic pole

Interchangeable graphics

Snap roller instead of self-adhesive leader



Standard



Elegant design with chrome finished end covers

Adjustable feet for greater stability



Adjustable foot

Delta Lite



- Snap rail with end caps
- Hybrid adjustable height telescopic pole
- Self-adhesive leader
- Adjustable feet
- Chrome finish end covers on base

Model	Code	↕ (h) x (w) x (d) mm
800 mm	UB250-800	2170 x 840 x 185 mm
850 mm	UB250-850	2170 x 890 x 185 mm
1000 mm	UB250-1000	2170 x 1040 x 185 mm

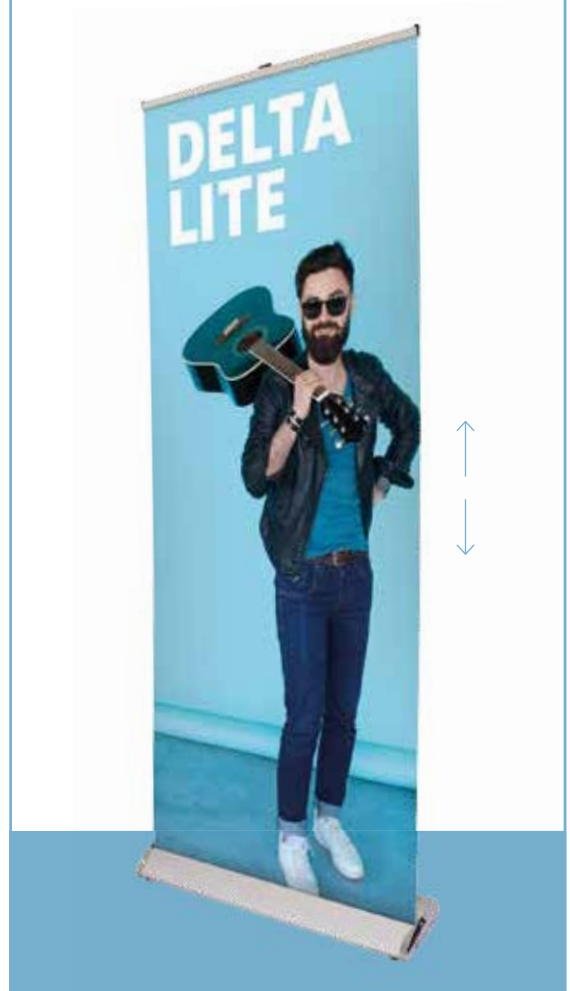

Stylish chrome finished end covers



Great economical banner

Blade+



- Snap rail with end caps
- Self-adhesive leader
- Hybrid adjustable height telescopic pole
- Adjustable feet
- Stylish end covers in chrome finish on base

Model	Code	↕ (h) x (w) x (d) mm
850 mm	UB509-850-01	2180 x 890 x 210 mm
1000 mm	UB509-1000-01	2180 x 1040 x 210 mm



Solo



- Snap rail with end caps
- Three parts bungee pole
- Single twist out foot
- Stylish chrome end covers and foot mouldings

Model	Code	↕ (h) x (w) x (d) mm
800 mm	UB114-800	2080 x 840 x 320 mm
850 mm	UB114-850	2080 x 890 x 320 mm
1000 mm	UB114-1000	2080 x 1040 x 320 mm



Economy



Sleek design with rounded end covers



Liberty



- Full graphic
- Snap rail with end caps
- Self-adhesive leader
- Three parts bungee pole and snap rail
- Two twist out feet

Model	Code	↗ (h) x (w) x (d) mm
800 mm	UB122-800-01	2080 x 830 x 350 mm
850 mm	UB122-850-01	2080 x 880 x 350 mm
1000 mm	UB122-1000-01	2080 x 1030 x 350 mm



Bungee pole



Self-adhesive Rail



Prism



- Self-adhesive rail with end caps
- Three parts bungee pole
- Grey end covers
- Two twist out feet

Model	Code	↗ (h) x (w) x (d) mm
800 mm	UB123-800-01	2080 x 830 x 350 mm
850 mm	UB123-850-01	2080 x 880 x 350 mm
1000 mm	UB123-1000-01	2080 x 1030 x 350 mm



Ultra compact!



Breeze



- Self-adhesive top rail with end caps
- Self-adhesive leader
- Anodised finish end covers
- Table top roller banner
- Does not come with a bag

Model	Code	↗ (h) x (w) x (d) mm
A4	WH360	335 x 238 x 80 mm
A3	WH361	440 x 332 x 82 mm



Liberty Mini



- Full graphic desktop roller banner
- Snap rail with end caps
- Self-adhesive leader
- Variable height : 400/800/1200/1600mm - 4 part pole*

- *Two part pole as standard for 400/800mm high. Optional extension poles for 1200/1600mm not included (EP-MINI)

Model	Code	↗ (h) x (w) x (d) mm
400 mm	UB122-400	450/850/1250/1650 x 430 mm x 125 mm



Economy



Mayfly



- Self-adhesive leader
- Three part bungee pole
- Rigidising bracket for extra strength
- Twin, twist out feet with plastic moulded ends



Model	Code	↙ (h) x (w) x (d) mm
800 mm	UB210-800	2090 x 816 x 350 mm
850 mm	UB210-850	2090 x 866 x 350 mm

Firefly



- Snap rail with end caps
- Self-adhesive leader
- Three part bungee pole
- Twin, twist out feet with plastic moulded ends



Model	Code	↙ (h) x (w) x (d) mm
800 mm	UB206-800	2090 x 816 x 350 mm
850 mm	UB206-850	2090 x 866 x 350 mm
1000 mm	UB206-1000	2090 x 1016 x 350 mm



Ideal for retail environments!



Firefly Mini



- Snap rail with end caps
- Self-adhesive leader
- Three part bungee pole plus extender
- Single twist out foot with plastic end



Model	Code	↙ (h) x (w) x (d) mm
600 mm	UB206-600	1690/2090 x 615 x 310 mm

Wasp



- Snap rail with end caps
- Three part bungee pole
- Twin, twist out feet
- Self-adhesive leader
- Rigidising bracket for extra strength



Snap Rail



Model	Code	↙ (h) x (w) x (d) mm
800 mm	UB204-800-03	2080 x 815 x 320 mm
850 mm	UB204-850-03	2080 x 865 x 320 mm
1000 mm	UB204-1000-03	2080 x 1015 x 320 mm

Economy

Grasshopper Roller Banner

Grasshopper banners are the market leading roller banner and offer excellent value for money. They come in a large choice of sizes and can therefore meet the requirements of any situation.

With reinforced casing and a padded bag for protective transportation, Grasshopper banners continue to be the original and the best display solution.



Also available in Grand Format

Grasshopper



- Self-adhesive rail with end caps
- Bungee pole
- Self-adhesive leader
- Twin twist out feet - larger on Grand Format sizes for ultimate stability



Bungee pole

Model	Code	↗ (h) x (w) x (d) mm
800 mm	UB191	2105 x 860 x 285 mm
850 mm	UB193	2105 x 910 x 285 mm
1000 mm	UB191-1000	2105 x 1060 x 285 mm
1200 mm	UB191-1200	2105 x 1260 x 285 mm
1500 mm	UB191-1500	2105 x 1560 x 285 mm

Twin twist-out feet - larger on Grand Format sizes for ultimate stability



Rigidising bracket increases the longevity of the banner



Telescopic pole

Mosquito



- Snap rail with end caps
- Self-adhesive leader
- Three part bungee pole
- Steel weight for improved stability
- Rigidising bracket for improved strength
- Twin twist-out feet with plastic ends

Comes in six widths!

Model	Code	↗ (h) x (w) x (d) mm
800 mm	UB197	2105 x 860 x 285 mm
850 mm	UB196	2105 x 910 x 285 mm
1000 mm	UB197-1000	2105 x 1060 x 285 mm
1200 mm	UB197-1200	2105 x 1260 x 285 mm
1500 mm	UB197-1500	2105 x 1560 x 285 mm
2000 mm	UB197-2000	2105 x 2060 x 285 mm



Giant Mosquito



- Snap rail with end caps
- Self-adhesive leader
- Telescopic pole can be set at various heights up to 3m
- Twin, twist-out large feet

Up to 3m high!

Model	Code	↗ (h) x (w) x (d) mm
850 mm	UB300-850	3100 x 869 x 400 mm
1000 mm	UB300-1000	3100 x 1019 x 400 mm
1200 mm	UB300-1200	3100 x 1219 x 400 mm
1500 mm	UB300-1500	3100 x 1519 x 400 mm
2000 mm	UB300-2000	3100 x 2019 x 400 mm



Double-sided



Exclusive premium banner



Double-sided banner with stylish chrome end covers

Excaliber2



- Premium double-sided banner with dual action self-adhesive and snap rail with secure end caps
- Self-adhesive sliding leader
- Hybrid adjustable height telescopic pole
- Adjustable feet
- Linear accessory channel and accepts an LCD screen (max weight 5kg)*
- Ratchet tensioner
- Please note 1200/1500/2000mm are supplied with two poles and 2400mm with three poles

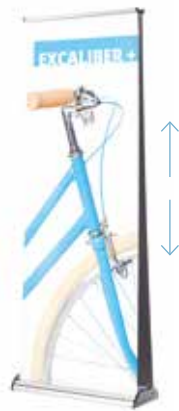

Model	Code	↕ (h) x (w) x (d) mm
800	WH311C-800A3	2220 x 860 x 275 mm
1000	WH311C-1000A3	2220 x 1060 x 275 mm
1200	WH311C-1200A3	2220 x 1260 x 275 mm
1500	WH311C-1500A3	2220 x 1560 x 275 mm
2000	WH311C-2000A3	2220 x 2060 x 275 mm
2400	WH311C-2400A3	2220 x 2460 x 275 mm

* LCD screen not included

Edge2



- Double-sided banner
- Snap rails with end caps
- Three part bungee pole
- Chrome finished end covers

Model	Code	↕ (h) x (w) x (d) mm
850	UB200-850	2100 x 890 x 190 mm
1000	UB200-1000	2100 x 1040 x 190 mm



Dragonfly2



- Double-sided banner
- Snap rail with end caps
- Self-adhesive leader
- Three part Bungee pole
- Twin, twist-out feet with plastic ends

Model	Code	↕ (h) x (w) x (d) mm
850	UB199-850-01	2105 x 890 x 395 mm
1000	UB199-1000-01	2105 x 1040 x 395 mm

Great economical double-sided banner





Vision Banners

The most exclusive range in the market, Vision Banners offer a solution for all needs and all budgets. Made from recycled plastic, the Vision range is an elegant and original way to communicate your message.

Available Autumn 2017



Exclusive design



Revolution



- Bright white plastic injected roller banner
- Snap-on rail with adhesive slider mechanism
- Self-adhesive leader
- White hybrid telescopic pole
- Grey anthracite under carriage
- Ultra-durable EVA bag for better protection



Model	Code	↗ (h) x (w) x (d) mm
850 mm	UB167-850	2260 x 900 x 225 mm

Pioneer



- Recycled white plastic roller banner
- Aluminium snap rail with end caps
- Self-adhesive leader
- Aluminium three part bungee pole
- Dark grey plastic end covers



Model	Code	↗ (h) x (w) x (d) mm
800 mm	UB147-800	2095 x 845 x 225 mm
850 mm	UB147-850	2095 x 895 x 225 mm
1000 mm	UB147-1000	2095 x 1045 x 225 mm



Element



- Recycled white plastic roller banner
- Aluminium snap rail with end caps
- Self-adhesive leader
- Aluminium three part bungee pole
- Dark grey plastic twin, twist-out feet



Model	Code	↗ (h) x (w) x (d) mm
800 mm	UB146-800	2090 x 830 x 280 mm
850 mm	UB146-850	2090 x 880 x 280 mm
1000 mm	UB146-1000	2090 x 1030 x 280 mm



Mini desktop banner

Stellar



- White injected plastic desktop banner
- White adhesive rail
- Self-adhesive leader
- External Tensioner
- White two part pole

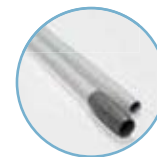

Two part pole

Model	Code	↗ (h) x (w) x (d) mm
A4	UB162-A4	320 x 231 x 78 mm
A3	UB162-A3	444 x 312 x 78 mm



Modular

Aero+



- Linkable and reconfigurable roller banner system
- Graphics can be adjusted to five fixed points along the post*
- Multiple positions to suit area, add sections as required
- Folding feet for easy shipping

*Depending on configuration

Model	Code	↗ (h) x (w) x (d) mm
1000 mm	UB222-1000	2120 x 1600 x 500 mm
1500 mm	UB222-1500	2120 x 2100 x 500 mm
2000 mm	UB222-2000	2120 x 2600 x 500 mm
Base and Post	UB222-P	2120 x 500 x 500 mm
Base only	UB222-B	500 x 500 mm



Folding feet



Adjustable collar on telescopic legs



Unique cassette locking system



Tension graphic

Accessorise your Aero+

Model
Clamp for Aero+
Bracket for iPad
iPad Holder
in white/silver/black

Code
UB222-01
FX837
IPAD-CHU-W/S/B



Clamp for Aero+



Bracket for iPad



iPad Holder*

Model
Clamp for Aero+
Bracket for Leaflet Holder
Leaflet Holders DL/A5/A4

Code
UB222-01
FX839
AH5DLP/A5P/A4P



Clamp for Aero+



Bracket for Leaflet Holder



Leaflet Holder

Model
Clamp for Aero+
Bracket for Table
Table shapes in round/triangle/square

Code
UB222-01
FX838
LN133-R/T/S



Clamp for Aero+



Bracket for Table



Table

*iPad not included



1. Wedge
2. Vortex
3. Uno

Tension Banners

Our most versatile range of banners, designed to fit into any space and provide a seamless image and backdrop that gives maximum impact.

Our Tension Banner systems can be modular and linkable to create any size and shape, or simple stand-alone units, making them versatile and easy to use. They are available in a wide range of substrates.



Perfect for situations where you need to change your message frequently, such as a retail or show environment.

Our Tension Banners are a popular and cost-effective solution that allows for the quick and easy changeover of graphics. Many also come supplied with sturdy nylon bags for ease of transport.

Our banners come in a wide variety of sizes, from a height of 1500 to 2900mm, and widths ranging from 300 to 1600mm. For more flexible solutions, our Uno and Stealth banners can be linked to create modular systems that can be re-configured to make the best use of the space you have.

Choosing the Right Tension Banner

1. Will your banner need to be packed up and moved regularly?
2. How often will the banner be re-used and need a change of graphic?
3. What is the size of the footprint that you need to use your banner within?
4. Do you have any height restrictions?
As our banners can be provided in a range of heights to take advantage of vertical spaces or limitations.
5. Are you deploying in high traffic environments? As our banners are supplied with a range of bases to suit each space.
6. Finally, determine your budget and choose the best quality to suit your needs.

// Graphic Attachments



Snap Rail



Zip Cover



Aluminium Frame
for Silicone Edged
Graphics

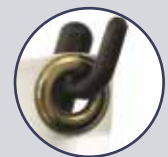

Eyelets

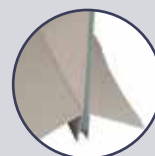

Panel Recess



Adhesive Slider

Formulate Tension Banners

Formulate Snake



- Free-standing banner manufactured from strong but lightweight 32mm diameter aluminium tubing
- Dress with washable, zipped tension fabric graphic
- Customisable with double-sided print
- Tool-free for easy assembly, gloves included

Model	Code	↕ (h) x (w) x (d) mm
Formulate Snake	FMSS-VS-01	2280 x 915 x 700 mm

Formulate Slant



- Free-standing banner manufactured from strong but lightweight 32mm diameter aluminium tubing
- Dress with washable, zipped tension fabric graphic
- Customisable with double-sided print
- Accessorise with shelf, literature or iPad holder*

Model	Code	↕ (h) x (w) x (d) mm
Formulate Slant	FMSS-VS-02	2280 x 915 x 650 mm

Formulate Curl



- Free-standing banner manufactured from strong but lightweight 32mm diameter aluminium tubing
- Dress with washable, zipped tension fabric graphic
- Customisable with double-sided print
- Accessorise with shelf, literature or iPad holder*

Model	Code	↕ (h) x (w) x (d) mm
Formulate Curl	FMSS-VS-03	2280 x 915 x 480 mm



Double-sided graphics for maximum exposure ↻



Formulate Monolith



- Free-standing banner manufactured from strong but lightweight 32mm diameter aluminium tubing
- Dress with washable, zipped tension fabric graphic
- Customisable with double-sided print
- Tool-free for easy assembly, gloves included
- Accessorise with shelves, leaflet or iPad holders*
- Metal base with carry handle for extra stability

Model	Code	↕ (h) x (w) x (d) mm
600 mm	FMSS-VSS-01	2300 x 650 x 250 mm
900 mm	FMSS-VSS-02	2300 x 955 x 250 mm
1200 mm	FMSS-VSS-03	2300 x 1240 x 250 mm
1500 mm	FMSS-VSS-04	2300 x 1544 x 250 mm

↪ Easy to dress with the tensioned fabric graphic



Numbered tubes for easy assembly



Base carry handle for easy transportation

*Optional extras, iPads not included

Stealth



- Modular, linkable banner system
- Create seamless graphic back walls
- Link single or double-sided units and position at different angles for extra impact*

Model	Code	(h) x (w) x (d) mm
800 mm	UB106	2115 x 800 x 350 mm



Flexible panel information units



Free-standing exhibition booths



Large area event backdrops

Easy magnetic linking panels



Reconfigure and angle to maximise your display space



* Minimum panel width of 600mm. Double-sided graphics on straight configurations only



Stealth case can store; two Stealth units, one flexible joining panel and one graphic wrap

Stealth Accessories

From case to counter!

- Add to your Stealth banner display with a range of stylish optional extra accessories. Choose from; thermoformed shelves, acrylic literature holders in DL, A5 and A4 sizes, LCD screen/iPad holder bracket* and LED lights
- Sturdy case for transportation or storage also transforms into a counter with a stylish graphic wrap
- 700mm and 250mm extension kits can create taller, more striking backwall displays

Model	Code	h x (w) x (d) mm
Shelf	LNST-002	N/A
DL Acrylic Literature Holder	LNST-DLP	N/A
A5 Acrylic Literature Holder	LNST-A5P	N/A
A4 Acrylic Literature Holder	LNST-A4P	N/A
LCD Screen / iPad Bracket*	UB106-SMK1	N/A
Design iPad Holder in Black*	IPAD-CHU-B	370 x 225 mm
Design iPad Holder in White*	IPAD-CHU-W	370 x 225 mm
Design iPad Holder in Silver*	IPAD-CHU-S	370 x 225 mm
Stealth Case	N/A	N/A
Folding Tabletop for Case (case not included)	CO332	565 x 475 x 15 mm
Case Graphic Wrap (case not included)	CO333Z	800 x 1600 mm
Extension Kit 700mm	UB106-005	N/A
Extension Kit 250mm	UB106-006	N/A
300mm Flexi Joining Kit	UB106-004	N/A
600mm Flexi Joining Kit	UB106-001	N/A
LED Flood Light Kit (Kit includes; 2x flood lights and transformer)	LED-FLOOD-ARM-BDLK	N/A



Thermoformed Shelf



Literature Holder



Design iPad Holder



LCD Screen / iPad Bracket



Stealth Case



Case folding Tabletop and Graphic Wrap

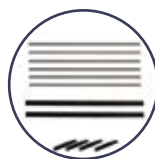

Flexi Joining Panel Kits



Extension Kits



LED Flood Light - see Lighting section for more options



700mm Extension kit (approx.) 2815mm

*LCD and iPad not included. †Maximum screen weight: 5kg



Uno



- Black tension L shape banner
- Banners are linkable to form larger backwalls
- Top and bottom dual action rails with gripper for PVC panels and a SEG channel for textile graphics.
- Suitable for PVC or textile fabric
- Variable height hybrid telescopic pole
- Extension pole to increase height up to 3m (UB101C-EP)
- Modern foot design
- Complete with bag and graphics cardboard tube

Model	Code	(h) x (w) x (d) mm
800 mm	UB101C-800-B	2210 (max) x 800 x 365 mm
1000 mm	UB101C-1000-B	2210 (max) x 1000 x 365 mm



Modern foot design



Linking banner rail



Link up to three PVC banners together, or five fabric banners as one impressive graphic wall

Vortex



- Free-standing tension banner in fibre and aluminium
- Graphic attached by eyelets
- Complete with bag

Model	Code	(h) x (w) x (d) mm
855 mm	UB722-C	1950 x 855 x 950 mm



Reinforced feet for stability

Wedge



- Steel banner base
- Supports a variety of rigid materials from 3mm to 40mm thick depending on substrate
- Suitable for temporary outdoor use

Model	Code	(h) x (w) x (d) mm
300 mm	UB102-300-S	1500 x 300 x 360 mm
600 mm	UB102-600-S	1500 x 600 x 360 mm
800 mm	UB102-800-S	1500 x 800 x 360 mm
1000 mm	UB102-1000-S	1500 x 1000 x 360 mm

Graphic can be wider than the base



Secure invisible fastening



CNC available for custom shaped graphics*

*Optional extra



1. Zoom+ Feather
2. Street Flag
3. Wind Dancer (4m)

Flags

For both outdoor and indoor use, flags are an eye-catching option for displaying your message or giving directions.

There are a wide range of options available, from on-the-move street flags to our highly popular Zoom+ flags.



Flags are one of the most striking display options available.

Our flags can be made in a wide range of sizes, materials and finishes suitable for everyday environments such as tarmac, grass and for specialist environments including water, sand and snow.

No matter in which environment you wish to use our flags, we can provide a suitable construction and base that will serve your needs.

Caring For Your Flags

Flags are often exposed to the harshest conditions, even the highest quality materials and finishes will suffer if not treated with care. Here is our guide on how to take simple care of your flags:

1. **Consider the positioning of your flag to minimise the effects of the environment.**
Air pollution can turn white areas grey, and too much UV light can cause fading and fabric deterioration.
2. **Reducing the flying time will preserve the life of your flag.**
A flag will last between six and eight months when flown constantly, so taking down the flag when not in use will help it to last longer.
3. **Take note of the climatic conditions.**
Flags should be taken down during poor weather conditions. Heavy rain and strong winds can increase the weight of the flag and put extra strain on the flagpole. Our flags are designed to withstand up to 18mph winds as standard.
4. **Washing your flag.**
Flags can be machine washed with everyday soft detergents on a 30° wash. They should always be allowed to dry out completely before folding and storing.

// Flag Shapes Available

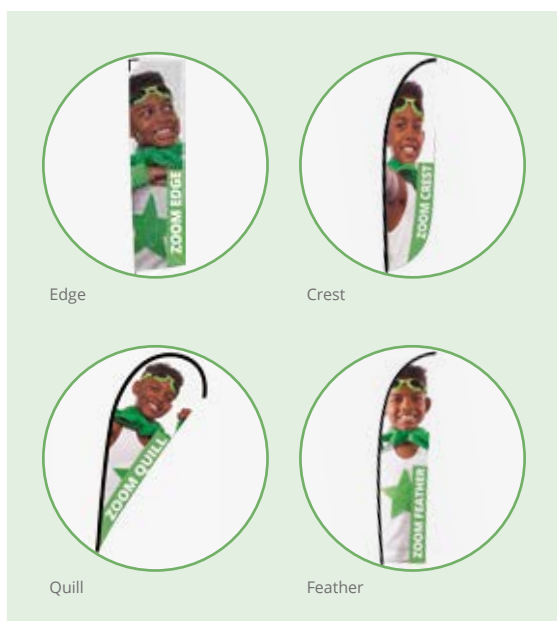

// Flags For All Locations



// Printing and Finishing

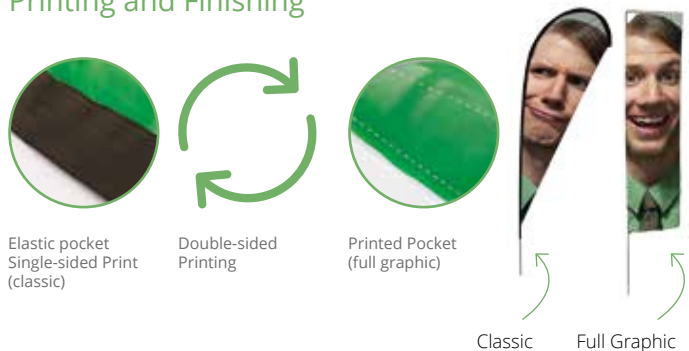

Formulate Lite Flags

Formulate Lite flags create a simple yet stunning outdoor display. Ideal for event signage, they can be sited on many different terrains with one of our many flag bases.

Formulate Lite



- Strong durable flag poles made from 25mm aluminium tube
- Fast and easy assembly
- Toggle securing feature keeps optional flag graphic taught
- Choice of bases to suit most surfaces
- Tested in wind speeds of up to 18mph/29km/h

Three different shapes and a choice of sizes!

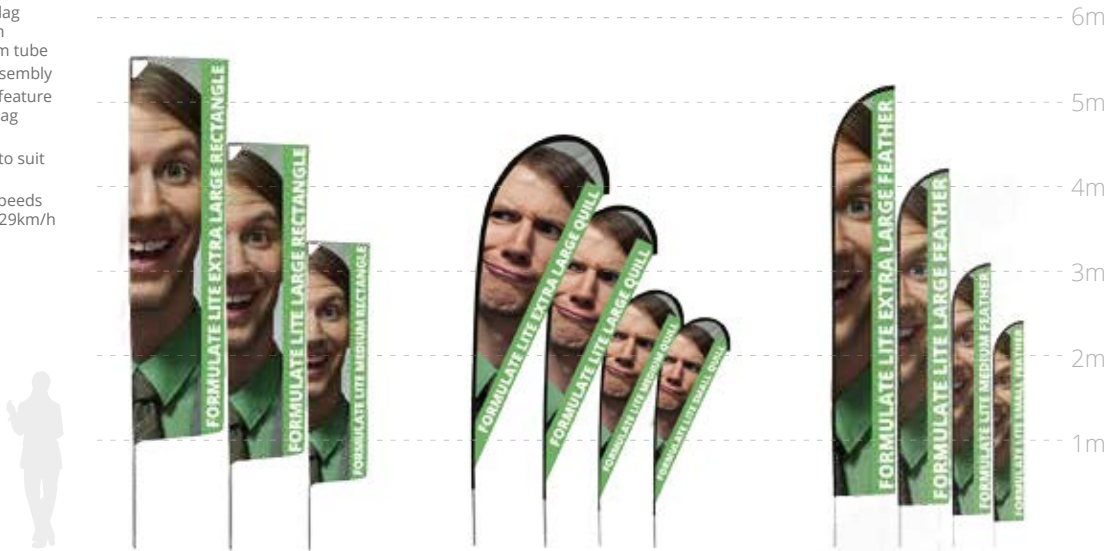

25mm Aluminium tubing

Rectangle Formulate Lite

Model	Code	♣ (h) x (w) mm
Extra Large	UF-FLR-XL	5510 x 820 mm
Large	UF-FLR-L	4505 x 820 mm
Medium	UF-FLR-M	3505 x 720 mm

Quill Formulate Lite

Model	Code	♣ (h) x (w) mm
Extra Large	UF-FLQ-XL	4580 x 930 mm
Large	UF-FLQ-L	3710 x 836 mm
Medium	UF-FLQ-M	2860 x 734 mm
Small	UF-FLQ-S	2300 x 620 mm

Feather Formulate Lite

Model	Code	♣ (h) x (w) mm
Extra Large	UF-FLF-XL	5135 x 725 mm
Large	UF-FLF-L	4195 x 675 mm
Medium	UF-FLF-M	3245 x 625 mm
Small	UF-FLF-S	2475 x 575 mm

Recommended bases:

Codes	Small Water Base	Large Water Base	Small Square Base	Small Cross Base	Large Cross Base	Budget Ground Spike	Standard Ground Spike	Plastic Ground Stake	Concrete Base	Drive On Car Foot	Please Note: † Requires the use of a weighted water ring and heavy duty pegs †† Requires the use of a weighted water ring Weighting Ring UB719-C 1x Heavy Duty Peg FX620	
	WD102B-01	UF-ZMLWB-01	UF-ZMLSQ-01	UF-ZMSCB-01	UF-ZMLCB-01	UF-ZMBGS-01	ZF-ZMGS-01	UF-ZMPSS-01	UF-ZMCEM-01	UF-ZMCF5-01		
Formulate Lite Flags	Bases											
	Rectangle	Small	N/A	N/A	N/A	N/A	N/A	N/A	N/A	N/A	N/A	N/A
		Medium	●	●	●†	●†	●	●	●	●	●	
		Large		●	●†		●†	●	●	●	●	
		Extra Large		●	●†		●†	●	●	●††	●	
	Feather	Small	●	●	●†	●†	●	●	●	●	●	
		Medium	●	●	●†	●†	●	●	●	●	●	
		Large		●	●†		●†	●	●	●	●	
		Extra Large		●	●†		●†	●	●	●††	●	
	Quill	Small	●	●	●†	●†	●	●	●	●	●	
		Medium	●	●	●†	●†	●	●	●	●	●	
		Large		●	●†		●†	●	●	●	●	
Extra Large			●	●†		●†	●	●	●††	●		

Zoom+ Flags

Zoom+ flags are a popular, versatile and lightweight flag range. They are ideal for all types of indoor or outdoor displays and events, and at over five metres high, they really make an impact.

Zoom+ Edge



- Flexible flag system; black finish all fibre pole which comes in a choice of sizes from 2m to 5m
- Suitable for lightweight fabric graphics (optional extra)
- Tested in wind speeds of up to 18mph/29km/h

Model	Code	↕ (h) x (w) mm
Extra Large	UF-ZME-EXLA	5000 x 750 mm
Large	UF-ZME-LA	4000 x 750 mm
Medium	UF-ZME-ME	2900 x 750 mm
Small	UF-ZME-SM	2080 x 750 mm

Full graphic



Hook fastening



All fibre poles



Base carry bag AB105B
Post carry bag AB105P



Zoom+ Crest / Feather / Quill



- Flexible flag system; black finish all fibre pole which comes in a choice of four sizes
- Each flag can accommodate three different flag graphics; Crest, Feather or Quill
- Suitable for lightweight fabric graphics (optional extra)
- Tested in wind speeds of up to 18mph/29km/h

Classic graphic

Model	Code	↕ (h) x (w) mm (Approx)
Extra Large	UF-ZM-EXLA	4600 x 1200 mm
Large	UF-ZM-LA	3500 x 1100 mm
Medium	UF-ZM-ME	2800 x 900 mm
Small	UF-ZM-SM	2100 x 800 mm

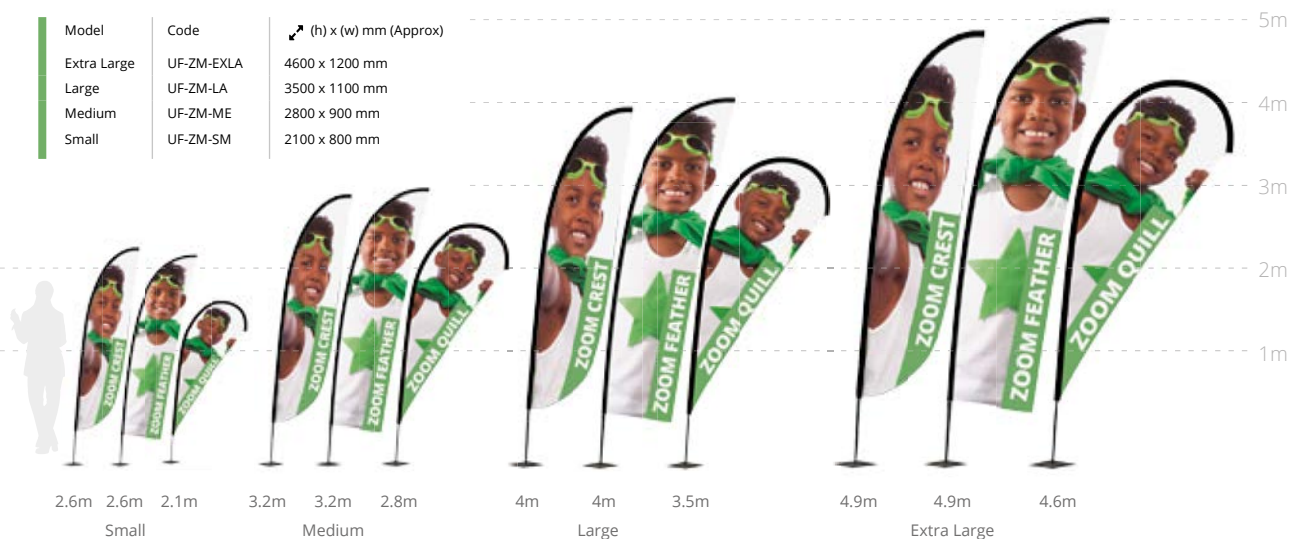

Bases for Zoom+ flags

Where flags are shown to be suitable for use with specific bases they have been tested in wind speeds of up to 18mph/29km/h

Bases			Zoom+ Flag shapes Edge / Quill / Crest / Feather				 Use with  Weighting Ring UB719-C	 Use with  Heavy Duty Peg FX620
Base	Code	Weight / Capacity	Extra Large	Large	Medium	Small		
	Small Water Base WD102B-01	12 Litres			●	●		
	Large Water Base UF-ZMLWB-01	30 Litres	●	●	●	●		
	Small Square Base UF-ZMLSQ-01	7.26 kg			○	○	○	○
	Large Square Base UF-ZMLSQ-03	11.78 kg	○	○	○	○	○	○
	Small Cross Base UF-ZMSCB-01	N/A			○	○	○	○
	Large Cross Base UF-ZMLCB-01	N/A	○	○	○	○	○	○
	Budget Ground Spike UF-ZMBGS-01	N/A			●	●		
	Standard Ground Spike ZF-ZMGS-01	N/A	●	●	●	●		
	Plastic Ground Stake UF-ZMPSS-01	N/A	●	●	●	●		
	Concrete Base UF-ZMCEM-01	22kg	○	●	●	●	○	○
	Drive On Car Foot UF-ZMCFS-01	N/A	●	●	●	●		
	Wall Mount UF-ZMWMF-01	N/A			●	●		

Stand-out on the water!



Zoom Aqua



- Tough telescopic pole for adjustable height up to 3.7m
- Kit includes anchor to keep in position in water; tether rope to retrieve flag from water, galvanised steel counter weight, pole and base
- For use in rivers, ponds and lakes with a minimum water depth of 1.2m and maximum 3.4m
- Not for use in open seas.

Model	Code	↗ (h) x (w) x (ø) mm
Aqua Feather	UB116	3700 x 785 x 360 mm
Aqua Quill	UB116	3200 x 1155 x 360 mm



Ballast weight and metal anchor included

Street Flag



- Promotional backpack that can be used with up to four different flag shapes*
- All poles and rods supplied with backpack
- Adjustable belt and padding for added comfort
- Full printing service available as an optional extra

- *All graphics are sold separately. Hardware is available to take all flag shapes

Model	Code	↗ (h) x (l) x (p) mm
Street Flag	UF-ZMSTF-01	540 x 310 x 80 mm

Get your message moving!

One bag but four different flag shapes



X-banner

Feather

Quill

Edge



Reinforced pole fixing system



Zipped storage for poles and rods



Reinforced straps, adjustable waistband and mesh pocket on the sides



Zipped compartment for flag storage

Shimmer



- Plastic, easy push-fit assembly black pole and base
- Telescopic pole extends height up to 2.85m
- Base with 14 litres capacity included (water or sand)
- Optional concrete base available (UF-ZMCEM)

Model	Code	↕ (h) x (w) x (ø) mm
Shimmer Base	WD102B-01	1470 - 2560 x 630 x 365 mm
Shimmer Pole	WD102P-01	
Graphic Bag	AB120D	
Graphic Bag with tubing	AB120DM	



14L capacity base

Wind Dancer 4m / 5m



- Aluminium pole and plastic base
- Telescopic pole extends height up to 4m or 5m accordingly
- Base capacities: 4m Wind Dancer 44L
5m Wind Dancer 66L
- Eyelet fixings for graphics
- Wind speed 13 - 18 mph/20 - 28km/h

Model	Code	↕ (h) x (w) x (ø) mm
4m (h)		2900 - 4150 x 800 x 630 mm
4m (h) Base	WD104B	
4m (h) Pole	WD104P	
5m (h)		4170 - 5300 x 1000 x 1000 mm
5m (h) Base	WD105B	
5m (h) Pole	WD105P	
Bag / 4m	AB212-C	
5m Pole Bag	AB105P	
5m Base Bag	AB105B	



Eyelet fixings



Base capacity 44L

Water or sand fill base

5m



Mistral



- Made from weatherproof aluminium castings and GRP tubes
- Can be wall mounted or fitted to lamp post
- Brackets can be moved for adjustable graphic height using fabric or vinyl
- Wind speed 18 - 25 mph/29 - 38km/h

N.B.

- We strongly recommend wind slits for continuous use in all weather conditions. Wind slits de-power banner flags.

Model	Code	↕ (h) x (w) mm
Mistral	UB725	Up to 2000 x 890 mm



Clamp and fastener



Wall mounting

Print & Finishing

We understand that when planning an event or exhibition your time is precious with potentially multiple suppliers to manage.

With our single source supply solution, leading industry expertise and incredible customer service, why not trust us to deliver both your product and printing requirements as a complete solution.

Our state of the art printing capabilities and expert sewing and finishing teams can save you time allowing you to concentrate on the finer details – growing your business.



Dye-sub, UV, latex and screen printing services



Laser cutting



Expert finishing

Dye-sub, UV, latex and screen printing services
all available in-house



Saving you time
to grow your business



1

2

3

Outdoor

1. Square Parasol
2. Inflatable Column
3. Shield

Outdoor

Choose from our comprehensive range of banners and signage for displaying your brand in a wide variety of indoor or outdoor locations. Our range also includes tents, counters and backwalls, sign boards and barriers for pedestrian guidance, not to mention our choice of inflatables and parasols.

Giving your message the impact it deserves in outdoor locations requires specialist, high quality solutions.



Choosing the right outdoor display product is important to ensure maximum branding impact and to attract your desired visitors and customers.

It is also critically important to make the right choice that will suit your environment; display area size, possible weather conditions, visitor numbers, mobility and repeat usage.

A taller display or a double-sided banner may make all the difference to the impact and performance of your branding.

Some Tips To Take Care Of Your Products

Outdoor products are designed for moderate outdoor usage during the daytime. But even high quality materials deteriorate if not treated with care and used in extreme weathers.

- 1. Choose your location carefully to minimise the effects of the environment.**
Air pollution can turn white to grey, UV rays can also alter the colour of your visuals and cause deterioration on materials used.
- 2. Optimise exposure time.**
By storing your Outdoor products between each use, their lifespan will be extended.
- 3. Consider climatic conditions.**
All Outdoor products are not weather resistant in the same way. Heavy rain combined with high winds may increase the risk of deterioration of certain products. Follow the instructions given in the data sheets of each product provided.

Designed For All Occasions

- Outdoor Exhibitions
- Music Festivals
- Markets
- Sport Events
- Outside Sales Outlets
- Fairs
- and many others!

Our Outdoor Range



Roller and Tension Banners



Inflatable Displays

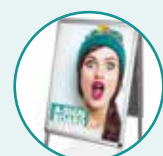

Pavement Signage



Pedestrian Guidance



Parasols



Signage

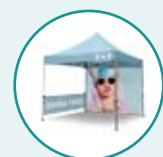

Tents



← One of our best sellers



Blizzard



- Adjustable rail for variable graphic width
- Telescopic pole for adjustable height
- Graphics attached by eyelets
- Stylish design with hollow plastic base for water or sand weighting
- Wind speed 13-18 mph/21-29km/h

Model	Code	(h) x (w) x (d) mm
Blizzard	UB701-C	2100 x 600/800 x 540 mm
Bag	AB140-C	N/A

Storm Hydro2



- Standard graphic height (approx.) 1800mm
- Single or double-sided indoor/outdoor banner
- Weather resistant
- Graphic attached by eyelets
- Moulded plastic base with capacity of 20L for water or sand weighting
- Wind speed 8-12mph/12-19km/h

Model	Code	(h) x (w) x (d) mm
Storm Hydro 2	UB209	2135 x 813 x 533 mm



Horizon



- Adjustable graphic height (approx.) 1500-2400mm
- Single or double-sided banner system
- Telescopic pole with bungee for adjustable height, giving up to 4.8m² per side
- Individual units can be joined together to form a wall
- Graphic attached with eyelets
- Two hollow feet with 28L capacity each for water or sand weighting
- Wind speed 8-12mph/12-19km/h

Horizon Pole Bag: AB195A (optional extra)
Horizon Base Bag: AB195B (optional extra)

Model	Code	(h) x (w) x (d) mm
Horizon	UB203	1500-3000 x 2500 x 800 mm
Joining Kit	UB203-001	(Optional extra)



Telescopic pole with bungee for adjustable height



Graphic attached with eyelets



Optional Joining kit available



← Double-sided

Easily transportable



Three part bungee pole



Twist lock feet

Thunder2



- Double sided outdoor roller banner
- Snap rail with end caps
- Self-adhesive leader
- Three part bungee pole
- Large removable twin feet
- Supplied with four ground pegs
- Wind speed if pegged 18-24mph/28-38km/h
- Wind speed if unpegged 4-7mph/6-11km/h

Model	Code	(h) x (w) x (d) mm
850 mm	UB185-850	2090 x 850 x 385 mm

Whirlwind



- Double-sided outdoor sign equipped with spring pivot for swing motion
- Wheeled compact moulded hollow base with a capacity of 25L(A1) or 55L(A0) for water or sand weighting
- Wind speed 13-18mph/20-28km/h
- Packs flat for easy transportation

Model	Code	(h) x (w) x (d) mm
A1 Base	UB207-B	1554 x 780 x 500 mm
A1 Frame	UB207-F	
A0 Base	UB207-A0-B	1554 x 1010 x 625 mm
A0 Frame	UB207-A0-F	



Wheeled hollow base for water or sand weighting



Snap frame



← Ideal for point of sale and pavement advertising

Stowaway



- Easily portable and light weight double sided structure
- Flag knit graphic attached to the metal tape pole with pocket
- Instantaneous opening and locking system using hook and loop fastening
- Supplied with four ground pegs

Model	Code	(h) x (w) x (d) mm
1400 mm	UB736-03	700 x 1420 x 400-480 mm
1700 mm	UB736-02	850 x 1720 x 400-480 mm
2000 mm	UB736-01	1000 x 2020 x 400-480 mm



← Hook and loop stability straps





A-sign Board



- Outdoor double-sided snap frame
- Galvanised steel backing adding extra strength and stability
- Graphic easy front loading, protected by soft PVC

Model	Code	↕ (h) x (w) x (d) mm
A1	VF204-C	1060 x 638 x 825 mm
A2	VF204-A2	884 x 465 x 595 mm

Sign Board Lite



- Double-sided sign board made from high impact polystyrene sheets and internal hinged mechanism
- Large graphic area ideal for self-adhesive or cut vinyl graphics

Model	Code	↕ (h) x (w) x (d) mm
750 mm	VF205	750 x 500 x 380 mm



Shield



- Rigid sign board with hard recycled rubber base, complete with securing bolts
- Choice of two different 1.2 mm aluminium graphic shapes curved or arched
- Print your message direct onto the aluminium

Model	Code	↕ (h) x (w) x (d) mm
Curved	UB108	800 x 465 x 450 mm
Arched	UB109	800 x 465 x 450 mm
Base	UB108B	465 x 450 mm



Monsoon

The Monsoon is a large format double-sided outdoor 'A' frame banner, made from lightweight aluminium, ideal for use with PVC eyelet banners.

This trusted best selling banner is also available in wall mounted format, suitable for indoor or outdoor use. Easy to fit graphic can be changed regularly to suit your needs.



Quick and easy installation



Graphic attached with eyelets



Metal hinges



Fixing the structure to the wall

Custom sizes available for single-sided wall banner

Wall Monsoon



- Wall mounted aluminium frame
- Easy push-fit assembly with plastic flush-fit joining, no tools necessary
- Graphic secured with adjustable looped bungee cord

Model	Code	↕ (h) x (w) x (d) mm
1250 mm	UB712	1250 x 1250 x 130 mm
2000 mm	UB713	1000 x 2000 x 130 mm
3000 mm	UB714	1250 x 3000 x 130 mm



Monsoon



- Double-sided A-frame banners
- Easy push-fit assembly with plastic flush-fit joining, no tools necessary
- Graphic secured with adjustable looped bungee cords and supplied with guide pegs
- Wind speed 18-24mph/28-38km/h

Model	Code	↕ (h) x (w) x (d) mm
2500 mm	UB707-C	1000 x 2500 x 640 mm
3000 mm	UB711-C	1250 x 3000 x 795 mm

Ideal for windy outdoor events



Available up to 3000mm wide

Economy Café



- Indoor and outdoor pedestrian guidance
- Graphic attached with multi-directional spring clips at the bottom, or optional rail
- Heavyweight black post and concrete base
- Sold as individual components

Model	Code	↗ (h) x (w) x (d) mm
1000 mm	UB214-1000	960 x 1140 x 355 mm
1500 mm	UB214-1500	960 x 1940 x 355 mm
2000 mm	UB214-2000	960 x 2440 x 355 mm
Base	UB214B	360 mm (diameter)
Post	UB214P	960 mm (height)
Spring clips (pair)	UB214-SC	



Multi-directional grip ring



Spring clips



Easy to assemble



Secure rail

Recommend using top and bottom rails

Deluxe Café



- Indoor and outdoor pedestrian guidance
- Graphic fixings by eyelet and/or sleeve
- Heavyweight stainless steel post and concrete base
- Sold as individual components
- Low cost Basics option available

Model	Code	↗ (h) x (w) x (d) mm
1000 mm	UB215-1000	960 x 1140 x 355 mm
1500 mm	UB215-1500	960 x 1940 x 355 mm
2000 mm	UB215-2000	960 x 2440 x 355 mm
Base	UB215B	360 mm (diameter)
Post	UB215P	960 mm (height)
Spring clips (pair)	UB215-SC	

Basics Leader



- Indoor and outdoor pedestrian guidance
- Posts available in black or silver
- Retractable webbing available in black, grey or red ●●●

Model	Code	↗ (h) x (w) x (d) mm
Post	SP-801	910 mm (height)
Belt	SP-803	2000 mm (length)
Base	SP-913	350 mm (diameter)



Retractable webbing cassette



Three colours

Silver or black posts and bases

Zoom Tent

There's plenty of room to shelter from the sun or rain underneath the Zoom Tent.

The foldable Zoom Tent has been designed specifically for all of your outdoor event needs. Made from lightweight aluminium, the Zoom Tent is very easy to assemble and packs back down into a strong and sturdy wheeled bag.

Ideal for markets, sporting events and receptions.



Quick and easy assembly and available in four colours or full graphic printing

Zoom Tent



- Zoom Tent kits include frame, ground pegs and 3.5m guy ropes
- Available options include: canopy, full wall, half wall with tube and clamp, weighted disc and printing
- Available in four colours black, blue, white, red ○ ● ● ●
- Custom printing available
- Wind speed 13-18 mph/20-28km/h
- Wheeled bag included

Zoom Tent Accessories

Model	Code
Weight 8kg	ZT-BASE



Optional weights 8kg



Optional canopy, full or half wall



Zoom Tent Kit

Model	Code	(h) x (w) x (d) mm
2x2	ZT22-XAF	3160 x 2000 x 2000 mm
3x3	ZT33-XAF	3160 x 2920 x 2900 mm

Zoom Double Tent Kit

Model	Code	(h) x (w) x (d) mm
3x6	ZT36-XAF	3160 x 5800 x 2920 mm

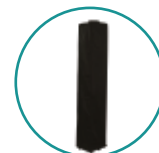

Wheeled bag comes as standard



Umbrella structure

Perfect for summer advertising

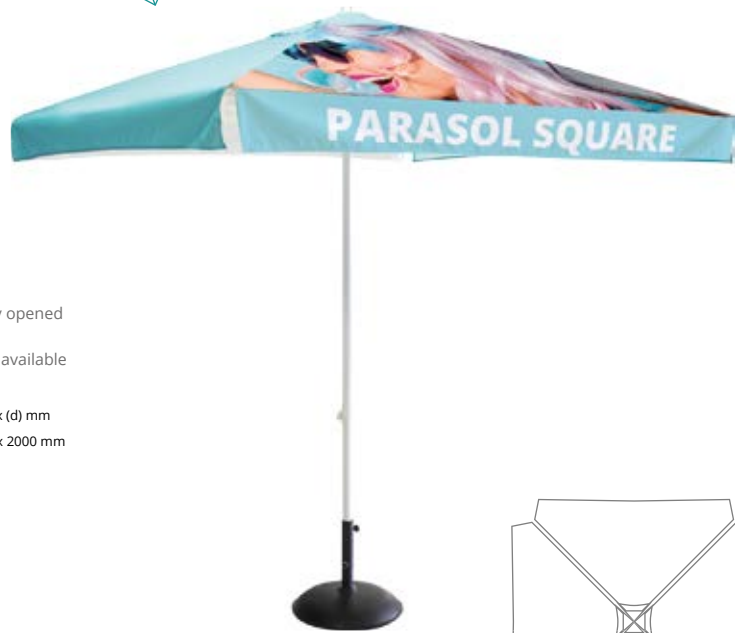

Square Parasol



- Ideal for outdoor events
- Square Parasol clicks into place when fully opened
- Carry bag included
- Optional extra base and printed canopies available

Model	Code	(h) x (w) x (d) mm
Square	UU-S-01	2600 x 2000 x 2000 mm
Base 20kg	UU-B-01	



Clamp opening and closing



Automatic locking

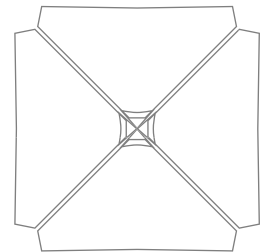

Circular Parasol



- Ideal for outdoor events
- Circular Parasol comes with winding handle for easy opening and closing as well as a safety chain and pin to prevent closing
- Carry bag included
- Optional extra base and printed canopies available

Model	Code	(h) x (Ø) mm
Circular	UU-C-01	2360 x 2660 mm
Base 20kg	UU-B-01	



Winding handle



Safety chain and pin

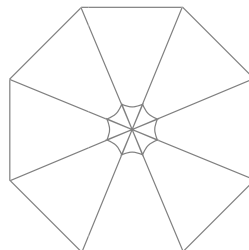

Recommended wind speeds 13-18 mph/20-28 km/h when used with the optional 20kg base

Get noticed in a crowd with our 2.2m inflatable column

Inflatable Column



- PVC Inflatable column including base with 15 litres capacity (pegs optional extra)
- Lightweight, portable, and easy to assemble in two minutes
- Fabric graphic (optional extra) is securely affixed over the inflatable column using hook and loop fastening around the base
- Trapped air technology: silent and free-standing once inflated
- Wind speed 13-18 mph/20-28km/h
- Optional carry bag available*

Model	Code	↕ (h) x (ø) mm
Column 2200	UI00212	2200 x 450 mm
15 litre water base	UI00340	
Carry bag*	UI003250	
Strip LED 2m / 220V	UI00376	



Plastic water base



Inflation valve



Interchangeable textile cover



Resists wind speeds of 13-18mph when pegged



Electric Pump



Model	Code
400w Electric Pump	UI00707



Hand Pump



Code
UI00704

Inflatable Tent



- Inflatable structure in TPU with removable polyester inner coat
- Trapped air technology: silent and free-standing once inflated
- 1 screw cap to inflate and 4 screw caps to deflate
- Wind speed 19-24 mph/ 29-38km/h
- Optional canopy and side walls available in three colours* ●●●

Model	Code	↕ (h) x (w) x (d) mm
Inflatable Tent Frame	UI00801	2460 x 3000 x 3000 mm
Canopy*	UI00815	
Side Wall (Blue)*	UI00816-B	
Side Wall (Dark grey)*	UI00816-DG	
Side Wall (Light grey)*	UI00816-LG	
20 Plastic Tent Pegs	UI00853-20	
20 Metal Tent Pegs	UI00854-20	



Inflation valve



Complete with carry bag

Perfect solution for outdoor events





1. Vector Quick Fix
2. Twista Lite
3. Free-standing Tablet Holder

POS Signage

Whether you are welcoming visitors or pointing the way, choosing the right signage is an important way of capturing attention.

We have a wide range of professional signage systems to choose from, including indoor, wall and poster frames, as well as free-standing and portable units for all your needs.



It is essential that Display Solutions match your interiors.

We have a comprehensive portfolio of Signage solutions suitable for different settings such as: corporate office interiors, reception areas, public spaces as well as commercial, point of sale and retail environments.

Our versatile display solutions have a range of quality components for easy installation and a wide choice of fixing options for wall or ceiling suspension where required. They are also available in different finishes that perfectly match surroundings.

Before Choosing Your Display Solution, Please Consider the Following:

1. Do you need Free-standing, Wall Mounted or Hanging Signage?
2. Does your display need to be printed or customised at all?
3. Does your signage need to be illuminated?
4. Do you plan to incorporate a device into the display like an LCD screen or iPad?

Our specialist Modular solutions ranges Twista and Strata are made to order, with a wide range of fixing options and finishes to blend perfectly into your environment.

// The Advantages of Our Range



Contemporary Designs



Custom Sizes and Colours



Quick and Easy Installation



Simple Graphic Attachment



Lightweight and Durable



Lockable for Security

Twista Lite



- Easy to use 'snap action' aluminium poster rail supplied with grey plastic end caps and hooks
- Smart modern design that can be wall or ceiling mounted
- For use with a range of media including, paper, card, PVC and fabric up to 300 microns
- Custom sizes available on request, up to 3000mm wide

Model	Code	↗ (h) x (w) x (d) mm
500 mm	TWLHR-500	31 x 500 x 12 mm
600 mm	TWLHR-600	31 x 600 x 12 mm
800 mm	TWLHR-800	31 x 800 x 12 mm
850 mm	TWLHR-850	31 x 850 x 12 mm
900 mm	TWLHR-900	31 x 900 x 12 mm
1000 mm	TWLHR-1000	31 x 1000 x 12 mm
1200 mm	TWLHR-1200	31 x 1200 x 12 mm
1500 mm	TWLHR-1500	31 x 1500 x 12 mm



Rail end cover



Remove cover, open rail, insert graphics, clamp shut, replace cover



Very cost-effective
snap-action solution

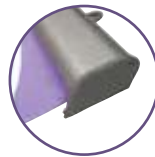

Rail end caps



Remove cover, open rail, insert graphics, clamp shut, replace cover

Trappa Rail



- Easy to use 'snap action' aluminium poster rail supplied in pairs with grey or black plastic end caps and hooks
- Smart modern design that can be wall or ceiling mounted
- For use with a range of media including, paper, card, PVC and fabric up to 300 microns

Model	Code	↗ (h) x (w) x (d) mm
210 mm (A4)	VH314	13 x 210 x 25mm
297 mm (A3)	VH313	13 x 297 x 25 mm
420 mm (A2)	VH312	13 x 420 x 25 mm
594 mm (A1)	VH311	13 x 594 x 25 mm
841 mm (A0)	VH310	13 x 841 x 25 mm
0.30 m	VH301	13 x 300 x 25 mm
0.50 m	VH302	13 x 500 x 25 mm
0.60 m	VH303	13 x 600 x 25 mm
0.90 m	VH304	13 x 900 x 25 mm
1.00 m	VH305	13 x 1000 x 25 mm
1.20 m	VH306	13 x 1200 x 25 mm

Great for retail environments

Strata System



Get a new perspective to your interior display. The Strata system is a versatile cable display solution with a choice of fixing options.

With a wide range of quality aluminium components for wall or ceiling suspension, Strata is available in silver satin or chrome finish for a stylish look.



Fastens from floor to ceiling



① Strata Lite Stand-offs

- Suitable for 2mm - 10mm thick substrates
- Choice of two diameters: 19mm and 12mm
- Quality aluminium components
- Available in satin or chrome finish
- Supplied in packs of four



Model	Code
19 (Ø) Satin	SP-SO1902
19 (Ø) Chrome	SP-SO1901
12 (Ø) Satin	SP-SO1202
12 (Ø) Chrome	SP-SO1201

② Stand-offs

- Suitable for 2mm - 10mm thick substrates depending on diameter used
- 16mm diam. stand-offs are suitable for substrates between 2 and 8mm thick/25mm diam. stand-offs are suitable for substrates between 5 and 20mm thick
- Choice of rail or screw fix options



Model	Code
Rail (Large)	P0101
Rail (Medium)	P0118
Rail (Small)	P0104
Screw (Large)	P0102
Screw (Medium)	P0117
Screw (Small)	P0105

Medium
P0118
P0117

Large
P0101
P0102

Small
P0104
P0105



③ Acrylic Poster Holder

- Acrylic poster holders have wings to take panel support fixings
- Available landscape or portrait
- Available in five sizes from A1 to A5

Model	Code
A1	AH411L/P
A2	AH412L/P
A3	AH413L/P
A4	AH414L/P
A5	AH415L/P



④ Double Panel Support

- Suitable for 4mm and 7mm thick substrates:
- 4mm - 10mm diam. x 20mm
- 7mm - 16mm diam. x 43mm with rotating feature for multi-angle fixing

Model	Code
10 mm (ø)	P0122
16 mm (ø)	P0121



⑤ Panel Supports

- Suitable for 4mm and 7mm thick substrates:
- 4mm - 10mm diam. x 15.5mm
- 7mm - 16mm diam. x 20.5mm

Model	Code
10 mm (ø)	P0113
16 mm (ø)	P0112



⑥ Aluminium Rail Screw Fixing

- Fix to ceiling or walls - cable fixings slot in and screw in to place
- Custom sizes available
- Complete with moulded end caps

Model	Code
1 metre	PR102
2 metres	PR101



⑦ Adjustable Fixing Cable

- 4m x 1.5mm Strata adjustable cable kit
- Supplied with rail fixings
- Can be fixed wall to wall, floor to ceiling, direct to wall - extra components required

Code	↗ (h) x (ø) mm
P0109	4000 x 1.5 mm



⑧ Rotating Edge Stand-offs

- Edge stand-offs eliminate the need for an aperture in the substrate
- Suitable for 2mm - 10mm thick substrates in rail or screw options
- Choice of sizes: 34mm x 16mm diam. and 34mm x 25mm diam. with distance from wall or ceiling 18.5mm approx.

Code	↗ (h) x (ø) mm
P0119	34 x 16 mm
P0120	34 x 25 mm



⑨ Compact Variable Wall Plate

- 16mm diam. x 25mm,
- 180° variable fixing
- 360° free moving or lockable
- Suitable for fixing to walls or ceilings

Code	↗ (h) x (ø) mm
P0106	25 x 16 mm



⑩ Compact Variable Cable Fixing

- 16mm diam. x 25mm, 180° variable fixing
- Choice of rail fix or screw fix options
- Cannot be used with PO110 cable kit

Model	Code
Rail	P0107
Screw	P0108



⑪ Floor to Ceiling Fixing Cable

- 4m x 1.5mm Strata adjustable cable kit
- Supplied with screw
- Not suitable for compact variable fixings

Code	↗ (h) x (ø) mm
P0110	4000 x 1.5 mm



⑫ Insert for Screw Fixing

- Suitable for PO109 Strata Cable Kits and Stand-off components

Code
P0116



⑬ Insert Rail Fixing

- Suitable for PO109 Strata Cable Kits and Stand-off components

Code
P0115

Vector Quick Fix



- Lightweight and extremely thin, anodised aluminium 20mm frame
- Easy assembly
- For use with fabric graphic with 3mm silicone beading
- For use as a wall frame or connect to a shell scheme with optional bracket fixing*
- Custom sizes available on request
- Extrusion can be cut to fit in a bag for easy transportation

Model	Code	↗ (h) x (w) x (d) mm
594 x 420 mm (A2)	VWQF-A2-01	594 x 420 x 20 mm
841 x 594 mm (A1)	VWQF-A1-01	841 x 594 x 20 mm
1189 x 841 mm (A0)	VWQF-A0-01	1189 x 841 x 20 mm
1.00 m	VWQF-1000-01	1000 x 1000 x 20 mm
Custom Size	VWQF-CUSTOM	Custom



Aluminium profile



Assembly with brackets



*Optional mounting bracket LN134

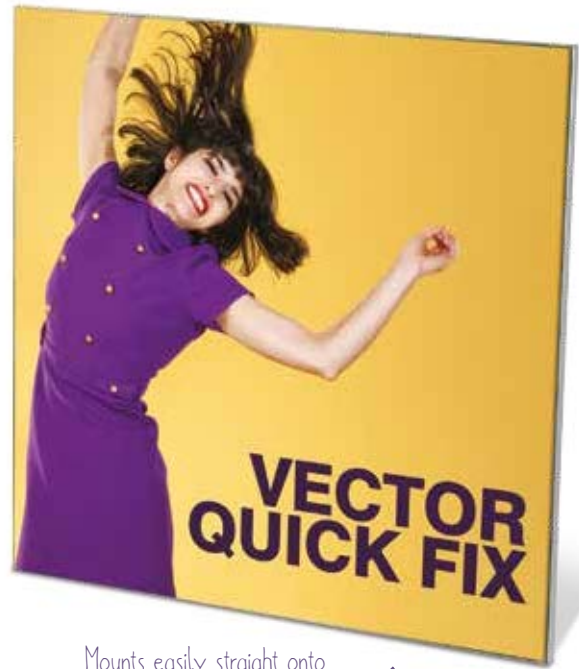

Mounts easily straight onto walls by self drilling



Ideal for dressing stands, shelf schemes, or for using as a partition

Partition fixing LN134



Fabric graphic with silicone edging inserts into frame



Illuminate your message

Available Summer 2017

Vector LED 30mm



- Wall mounted, illuminated and anodised aluminium 30mm frame
- Easy assembly with mounting angle
- For use with fabric graphic with 3mm silicone and beading
- Backlit illumination
- Custom sizes available on request
- Extrusion can be cut to fit in a bag for easy transportation

Model	Code	↗ (h) x (w) x (d) mm
Vector LED 30mm	VLB30-CUSTOM	Custom



Assembly with brackets

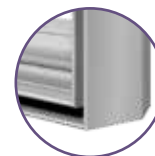

Aluminium profile



LED lighting

Trappa Frame



- Standard Trappa 25mm wide snap action frame in aluminium with anodised silver finish
- Wall mounted, portrait or landscape with mitred corners
- Clear PVC protection sheet supplied
- For use with a range of media including, paper, card, PVC and fabric up to 420 microns

Model	Code	(h) x (w) x (d) mm
A4	AT401-C	328 x 241 x 13 mm
A3	AT402-C	451 x 328 x 13 mm
A2	AT403-C	625 x 451 x 13 mm
A1	AT404-C	872 x 625 x 13 mm
A0	AT405-C	1220 x 872 x 13 mm



Snap frame



Custom sizes also available
- ask your dealer

LED Trappa Frame



- Standard Trappa 32mm wide snap action frame in aluminium with anodised silver finish
- Wall mounted
- Available in five sizes
- For use with a range of media including, paper, card, PVC and fabric up to 420 microns
- LED edge lit to all four sides creating exciting pictures

Model	Code	(h) x (w) x (d) mm
A4	MLAF13-A4	345 x 248 x 32 mm
A3	MLAF13-A3	468 x 335 x 32 mm
A2	MLAF13-A2	642 x 458 x 32 mm
A1	MLAF13-A1	889 x 632 x 32 mm
A0	MLAF13-A0	1227 x 889 x 32 mm



Snap frame



Power supply included

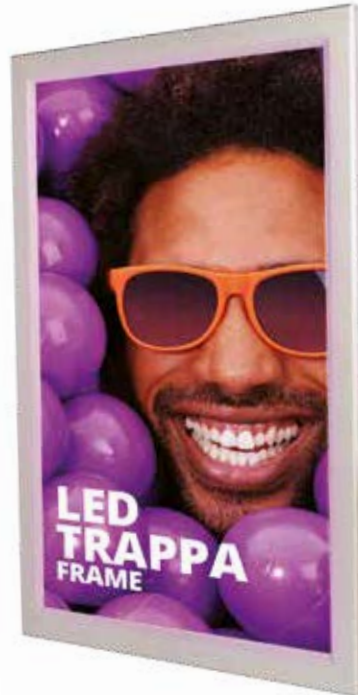

Low power consumption
LED frame

Cool to the touch



Can be used portrait
or landscape

Sentry



- Snap action, free-standing poster display
- Head rotates for either portrait or landscape format
- For use with a range of media including, paper, card, PVC and fabric up to 420 microns

Model	Code	(h) x (w) x (d) mm
A3	SL103	1075 x 278 x 326 mm
A4	SL104	1005 x 245 x 326 mm

Free-standing iPad Holder*



- Secure housing with security screws and Allen key
- Can be positioned portrait or landscape
- Complete with floor fixing bolts
- Available in three colours black, silver or white
- Compatible with: iPad 2,3, 4 and iPad Air*
- Not compatible with iPad Pro or iPad 1
- iPad not included*

Model	Code	↕ (h) x (ø) mm
Black	IPS-001-B	1045/1060 x 360 mm
Silver	IPS-001-S	1045/1060 x 360 mm
White	IPS-001-W	1045/1060 x 360 mm



In white



In silver

Rotate to use in portrait or landscape format



Free-standing Tablet Holder*



- Easy to assemble tablet holder, can be used landscape or portrait
- White or black plastic housing features lock for added security
- Aluminium post with cable management system
- Black steel foot, complete with bolts so you can fix to the floor
- Compatible with: iPad 1,2,3,4, Air, Samsung Tab 3 10.1, Samsung Galaxy Note 10.1(2014 model), ASUS Memo Pad 10.1, Samsung Tab Pro 10.1 and Sony Xperia 22*
- Available for all iPads except mini and iPad Pro*
- Tablet/iPad not included*

Model	Code	↕ (h) x (w) x (d) mm
Black	TS-001-B	1131 x 368 x 277 mm
White	TS-001-W	1131 x 368 x 277 mm



Adaptable tablet holder



Lockable



Can be used portrait or landscape

*Please note all tablets including iPads are not included and not available to purchase



Large base for extra stability



Telescopic iPad Holder*



- Secure black lockable housing with key entry
- Can be positioned landscape or portrait
- Height adjustable post with cable management system
- Large black steel base
- Complete with bolts so you can fix to the floor
- Accepts iPad 2, 3, 4 and iPad Air*
- iPad not included*

Model	Code	↗ (h) x (w) x (d) mm
Black	IPS-002-B	780 - 1225 x 440 x 350 mm



Tilting



Lockable

Design iPad Holder 360° Mount (optional)*



- Secure housing frame mounted on 360° iPad Holder
- Can be mounted onto a counter, wall or a Linear post
- Comes complete with all parts and fixing kit
- Available in black, silver and white surround
- Accepts all iPads excepts iPad mini or iPad Pro*
- iPads not included*

Model	Code	↗ (h) x (w) x (d) mm
Frame		
White	IPAD-CHU-W	310 x 225 x 20 mm
Silver	IPAD-CHU-S	310 x 225 x 20 mm
Black	IPAD-CHU-B	310 x 225 x 20 mm
Frame + 360° mount		
White	IPAD-SH-360W	310 x 225 x 95 mm
Silver	IPAD-SH-360S	310 x 225 x 95 mm
Black	IPAD-SH-360B	310 x 225 x 95 mm

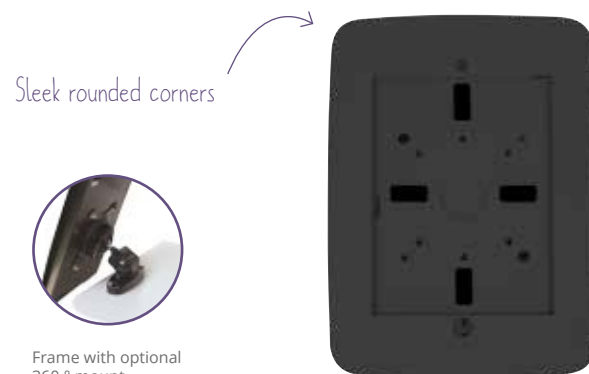

Frame with optional 360° mount

*Please note all tablets including iPads are not included and not available to purchase

Multi-functional LCD/LED/Plasma Stand



- Lightweight mobile stand comes in black
- Adjustable height with two heavy duty poles
- Capable of mounting 40"- 60" LCD, LED or plasma screens
- Comes with standard accessories; camera tray and AV accessories shelf
- Smooth rolling braked castors for easy transportation
- Integrated cable management system inside pole uprights
- LCD/LED/Plasma screen and Video/AV equipment are not included and not available to purchase

Model	Code	↕ (h) x (w) x (d) mm
Multi-functional Stand	LN250	1000 - 1500 x 850 x 730 mm



Folding Table



- Polypropylene and metal frame trestle table with folding legs
- Folds in half with carry handles for easy transportation
- Complete your look with a custom table cloth in display polyester printed with your design

Model	Code	↕ (h) x (w) x (d) mm
Table	FT-6	Open : 745 x 1835 x 750 mm Closed : 80 x 885 x 750 mm



Carrying handles



Locking rings



Easy folding

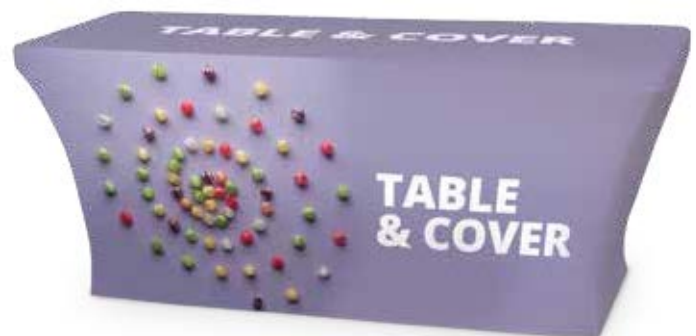

Optional Stretch Table Cloth
G-TAB-ST



Optional Table Cloth
G-TAB-3x2-DP

Reflecta Lite LED



- Free-standing, double-sided LED lightbox
- Two metre long mains lead and plug included
- Recommended graphic thickness 200 micron or equivalent (Graphics are optional extra)
- Packs flat for transit and storage

Model	Code	↖ (h) x (w) x (d) mm
Reflecta Lite LED	ML950	1330 x 490 x 295 mm

Single or double-sided light box



Easy change graphic



Plexiglas protective cover

Reflecta Trappa



- Free-standing double-sided lightbox or graphic pod
- Available with trappa style posts with easy to use 'snap action' aluminium rails to support a range of media types
- Supports Linear accessories (See page 6)
- Top and base available in 4 colours; silver, black, white or birch finish ●●○●

Model	Code	↖ (h) x (w) x (d) mm
840 mm (Lightbox)	MR914T	840 x 570 x 280 mm
840 mm	MR103T	840 x 570 x 280 mm
1040 mm (Lightbox)	MR911T*	1040 x 1000 x 400 mm
1040 mm	MR101T*	1040 x 1000 x 400 mm
1570 mm (Lightbox)	MR915T	1570 x 570 x 280 mm
1570 mm	MR104T	1570 x 570 x 280 mm
1840 mm (Lightbox)	MR912T*	1840 x 1000 x 400 mm
1840 mm	MR102T*	1840 x 1000 x 400 mm

* Protective panels in plexiglass and white panels to be printed are not included

Sleek elliptical shape



Spiral Plinth



- Collapsible display counter with self-locking system
- Complete with acetate panels and magnetic tape
- Can be customised by replacing acetate panels with printed graphics
- Complete with wheeled case

Model	Code	↕ (h) x (ø) mm
Spiral Plinth	UB710	1070 x 580 mm

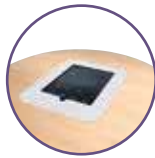

iPad[®] holder in white



iPad[®] holder in black

Shown with optional silver iPad[®] holder*
UB710-IPDM



* iPad not included

* To be purchased at time of ordering



Top-mounted downlighter

Customise with your own graphics

Spiral Display Tower



- Collapsible display tower with self-locking system
- Complete with acetate panels and magnetic tape
- Can be customised by replacing acetate panels with printed graphics
- Integral downlighter
- Complete with wheeled case

Model	Code	↕ (h) x (ø) mm
Spiral Display Tower	UB710-002	2070 x 560 mm





1. Pop-up Counter
2. Basic Round Counter
3. Lecturn Linear Counter

Counters

Designed for a wide variety of uses, our portable counters cater for almost any situation or occasion and are an ideal way to welcome your guests.

We have designed a comprehensive range of items in many shapes and sizes, most of which can support graphics that project your brand.



We provide counters for all budgets and requirements.

Our Counters can serve as display surfaces, lecterns, data pods, workstations, display towers, columns and plinths and the variations of what you can do with them is infinite.

You can also increase your impact by adding height and visibility with a header kit or flag. Our Counters are simple and quick to build with tool-less construction, they are made in-house and can be made to order if customisation is required.

Before Choosing Your Counter, Please Consider the Following:

1. How many times will it be used? Occasionally or regularly?
2. Do you need to transport it? And how often?
3. Will you need storage for catalogues for example?
4. Do you need to host visitors or give a lecture?

// Standard Solutions...

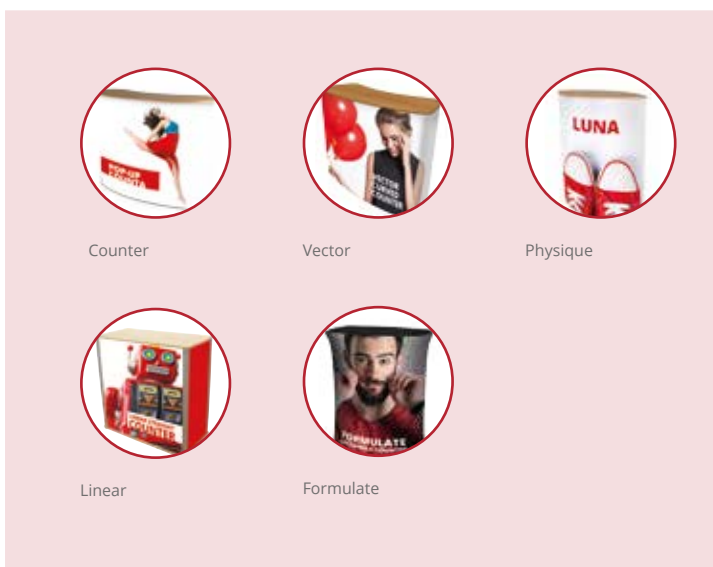

// ... Customisable Solutions

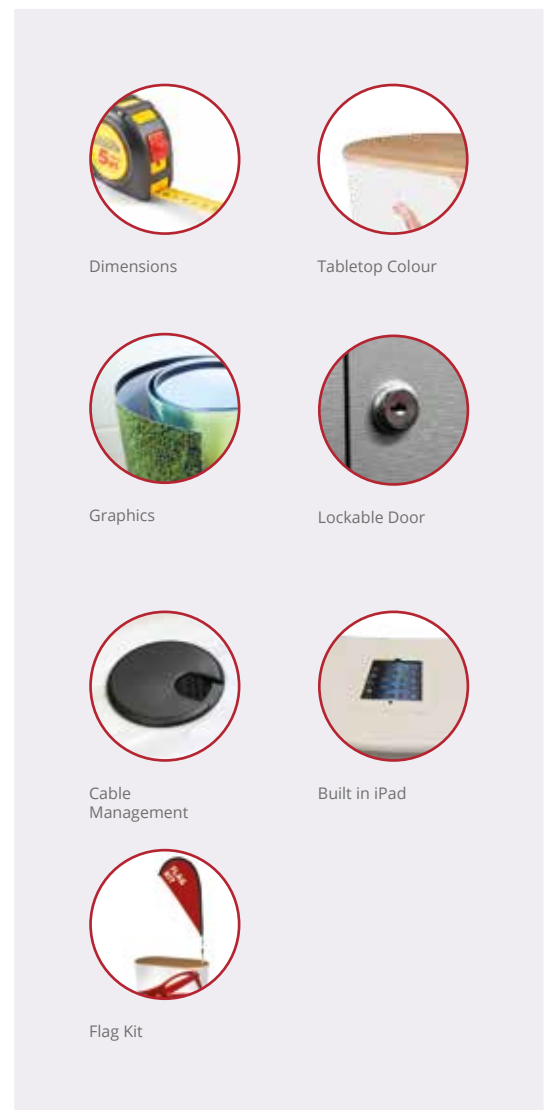



SEG* Fabric Counter



- Collapsible display counter with self-locking magnetic assembly
- Optional fabric Silicone Edged Graphic (SEG) that fits easily into the channel
- Thermoformed birch tabletop and base. Three extra colours options are available ●●○
- Two internal shelves for storage included

*SEG: Silicone Edged Gasket

Model	Code	↕ (h) x (w) x (d) mm
SEG	PUC21C-SEG	990 x 840 x 365 mm



Attaching the graphic into SEG channel



Carry case



Pop-up Counta



- Collapsible Pop-up counter with self-locking magnetic assembly
- PVC graphic attached with magnetic hanger and bars
- Thermoformed tabletop in birch effect
- Four internal shelves
- Supplied with reinforced D-shaped wheeled trolley case

Model	Code	↕ (h) x (w) x (d) mm
2x1	PUC21C-C	985 x 865 x 400 mm
2x2	PUC22C-C	985 x 1290 x 465 mm



Magnetic fixing



Wheeled trolley case

Hop-up Counta



- Collapsible Pop-up counter with single wrap around fabric graphic attached permanently with hook and loop strap
- Quick and easy to assemble
- Thermoformed birch tabletop
- Single internal shelf for storage included

Model	Code	↕ (h) x (w) x (d) mm
Hop-up	HU301-001-C	1020 x 1060 x 360 mm



Plastic locking arm



Wheeled trolley case



Vector Counter



- Easy to assemble aluminium frame
- Fabric graphic includes silicone edging to allow for simple insertion into frame
- Tabletop is available in four colours: ●●○●
- Optional internal shelf

Model	Code	↗ (h) x (w) x (d) mm
Vector	VCR-001	1015 x 1036 x 545
Internal shelf	VCR-IS	



Fabric graphic with silicone edging inserts into frame



Vector Curved Counter



- Easy to assemble aluminium frame with rounded corners
- Fabric graphic includes silicone edging to allow for simple insertion into frame
- Tabletop is available in four colours: ●●○●
- Optional internal shelf and carry bag

Model	Code	↗ (h) x (w) x (d) mm
Vector Curved	VCCB	1015 x 1340 x 540 mm
Tabletop and Shelf Bag	AB916	
Carry Bag Kit (Counter)	AB120AC-KIT	



Rounded corners



Carry bags

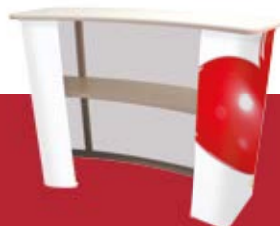



Steel literature holders are optional

Linear Lite Counter



- Anodised aluminium counter for 3-5 mm thick PVC foamed board graphics (not included, can be quoted for)
- Suitable for magnetic or infill panels
- Tool free and easy assembly thanks to twist and lock system
- Thermoformed wooden tabletop and base available in four colours ●●○●
- Optional internal shelf available on request

Model	Code	↗ (h) x (w) x (d) mm
Linear Lite	LK038	1040 x 915 x 405 mm
Carry bag	AB112A	
Case	AC311	
Internal shelf	PK8-S15	
A4 Steel Literature Holder	LN112-004	
A5 Steel Literature Holder	LN112-005	

Linear Curved Counter



- Anodised aluminium counter for 3-5 mm thick PVC foamed board graphics (not included, can be quoted for)
- Suitable for magnetic or infill panels
- Tool free and easy assembly thanks to twist and lock system
- Available in 30° and 45° radius
- Thermoformed wooden tabletop and base available in four colours ●●○●
- Optional internal shelf available on request

Model	Code	↗ (h) x (w) x (d) mm
Standard 30°	LK028-001	1010 x 1025 x 546 mm
Standard 45°	LK028-003	1010 x 1515 x 607 mm
Pro 30°	LK028-002	1010 x 1025 x 546 mm
Pro 45°	LK028-004	1010 x 1515 x 607 mm
Carry bag for 30°	AB112A	
Carry bag for 45°	AB221	
Internal shelf	PK8-S15	

Acrylic top shelf with stand-offs available on Pro version

Standard counter



Linear Straight Counter



- Anodised aluminium counter for 3-5 mm thick PVC foamed board graphics (not included, can be quoted for)
- Suitable for magnetic or infill panels
- Tool free and easy assembly thanks to twist and lock system
- Thermoformed wooden tabletop and base available in four colours ●●○●
- Optional internal shelf available on request

Model	Code	↗ (h) x (w) x (d) mm
1000 mm (l)	LK029-001	1010 x 1000 x 500 mm
2000 mm (l)	LK029-002	1010 x 2000 x 500 mm
Linear Counter Bag 1000 mm	AB112A	
Linear Counter Bag 2000 mm	AB222	
Internal shelf	PK8-S15	

Lecturn Linear Column



- Anodised aluminium column for PVC graphics (not included but can be quoted for)
- Thermoformed wooden tabletop and base available in four colours ●●○●
- Acrylic shelf supported with stand-offs
- Internal shelf with optional graphic panel to the front

Model	Code	↕ (h) x (w) x (d) mm
Lecturn Linear	LNC-LEFO	1015 x 640 x 325 mm



Available in LED versions

Linear Column



- Anodised aluminium column for PVC graphics (not included but can be quoted for)
- Internal LED lighting options of white or RGB
- Lightbox version comes with white panels, optional printing available
- Thermoformed wooden tabletop and base available in four colours ●●○●

Model	Code	↕ (h) x (w) x (d) mm
Standard	LNC-STFO	1010 x 640 x 325 mm
Standard LED	LNC-STLB	1010 x 640 x 325 mm
Slim	LNC-SLFO	1010 x 380 x 245 mm
Slim LED	LNC-SLLB	1010 x 380 x 245 mm

Gear Edge Counter



- Aluminium counter to compliment exhibition panel displays
- Graphic panels are very easy to change depending on your promotion or message
- Internal shelf included on straight counter only
- Tabletop available in four colours ●●○●

Model	Code	↕ (h) x (w) x (d) mm
Gear Edge Straight	GECS-FO/FC	920 x 830 x 450 mm
Gear Edge Curve	GECC-FO/FC	920 x 830 x 525 mm

FO: Frame only/FC: Fabric covered

Ideal for displaying your products



Gear Edge Display Counter



- Aluminium counter to compliment exhibition panel displays
- Transparent acrylic showcase
- Includes internal shelf and sliding door to the back
- Tabletop available in four colours ●●○●
- Available as frame only or complete with your choice of fabric (see page 102)

Model	Code	↕ (h) x (w) x (d) mm
Gear Edge Display	GECD-FO/FC	920 x 775 x 405 mm



Storage area



Quickly and easily folds flat for storage

Formulate Counters

360° visible fabric graphic



Formulate Large Rectangle Counter



- Ø32mm Aluminium tubular structure
- Fabric SEG (Silicone Edged Graphic)
- Black tabletop included
- Supports up to a maximum load of 50kg

Model	Code	↗ (h) x (w) x (d) mm
Formulate Large Rectangle	FMC-SQA-02	1015 x 1880 x 520 mm



Numbered tubes for easy assembly

Formulate Rectangle Counter



- Ø32mm Aluminium tubular structure
- Fabric SEG (Silicone Edged Graphic)
- Black tabletop included

Model	Code	↗ (h) x (w) x (d) mm
Formulate Rectangle	FMC-SQA-01	1015 x 800 x 530 mm



Lightweight portable counter



Numbered tubes for easy assembly

Formulate Oval Counter



- Ø32mm Aluminium tubular structure
- Fabric SEG (Silicone Edged Graphic)
- Black tabletop included

Model	Code	↗ (h) x (w) x (d) mm
Formulate Oval	FMC-OVA-01	1015 x 595 x 395 mm



Physique Range



Physique offers the largest range of flat pack counters for portable marketing. Physique is available in two specifications that give the same end look - one with fabric and one with a graphic (available for most designs). We can also manufacture our counters to your specification - please ask your dealer for details.

All standard Physique counters come with a standard foot. Locking castors and iPad holders are available for most counters too (at an optional extra cost).

Products come with a bag where marked, and we can also supply bags for all other products as an optional extra.

Step 1 : Choose your counter style

Choose from one of the six counter styles in the Physique range: Luna, Eclipse, Curved Workstation, Mercury, Comet or Double D.

Step 2 : Choose your assembly option

MDF Freestyle

- MDF Tambour wraps finished in a choice of fabric covering (See Step 3)
- Supports a maximum load of up to 75kg
- Attach graphics with hook and loop fastenings directly to the fabric
- Available for all products



Physique Pole Graphic

- Constructed with a unique twist and lock aluminium pole system
- Graphic is attached directly to the unit
- Lightweight structure
- Available for the Double D, Eclipse and Curved Workstation



Ideal as a greeting counter, workstation or product display unit



Luna



- Lightweight and very portable counter, ideal for road shows
- Low-profile shape with fine-grade fluted tambour for a smoother finish
- Twist and lock poles for added strength, integral shelf included

Model	Code	↕ (h) x (w) x (d) mm
Freestyle	PK113-F	1000 x 860 x 400 mm
Corex	PK113-W	1000 x 860 x 400 mm
Carry Bag	CBB-005	



Eclipse



- Only available as a full wrap option
- Robust and offers large capacity of storage

Model	Code	↕ (h) x (w) x (d) mm
Freestyle	PK152	1000 x 1000 x 500 mm
Pole Graphic	PT152	1000 x 1000 x 500 mm
Carry Bag	AB112A	



Curved Workstation



- Open back and full wrap options
- Lockable door and internal shelf available as option

Model	Code	↕ (h) x (w) x (d) mm
Freestyle	PK160	1000 x 1000 x 500 mm
Pole Graphic	PT160	1000 x 1000 x 500 mm
Lockable Door	RK322	
Internal Shelf	RK303	
Carry Bag	AB115A	

Step 3 : Choose the fabric type and colour

Choose from the two options:

- Luxury Foam Backed Nylon
- Smooth (formerly Prelude)

See all available colour options on page 102.

Step 4 : Choose the tabletop and base colour



Tabletop and base are available in four colours:

- Black
- Silver
- White
- Birch

Step 5 : Choose your accessories



Physique Header Kit

- Available for all products
- 1m high steel poles
- Comes complete with fixings
- Header is made from 3mm white foam board

Code	(h) x (w) mm
PKH001	Header: 300 x 950 mm Assembled size: 1200 x 950 mm



Physique Flag Kit

- Available for all products
- Flag sold separately

Code	(w) mm
PKF001	Pole: 1500 mm
PKF002	Pole Spigot



Flush Mounted Tabletop iPad* Holder

- Available for all products
- Suitable for iPad 2,3,4 and Air*
- Available in three colours ●●○

Code	(h) x (w) mm
IPDM-W/S/B	305 x 230 mm

*iPad not included



Mercury



- Open back and full wrap option
- LCD mount (up to 20"), acrylic shelf and cable management port included
- LCD monitor not included
- Internal shelf not included

Model	Code	(h) x (w) x (d) mm
Freestyle	PK190	1520 x 850 x 600 mm
Carry Bag	AB115B	
Internal Shelf	PK190T	

Available without banner



Comet



- Stylish tear drop counter for when you need to grab attention
- Integral aluminium literature holder
- Shown with optional integral banner and iPad* holder 360° (iPad not included)

Model	Code	(h) x (w) x (d) mm
Freestyle	PK189	1010 x 1010 x 655 mm
Freestyle with banner	PK189A	1800 x 1010 x 655 mm
Carry Bag	AB151	

Get spotted easily using the optional Flag Kit

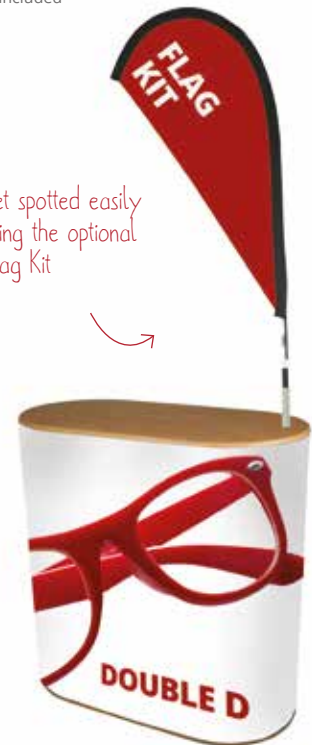

Double D



- Open back and full wrap options
- Lockable door available as option, please contact for advice

Model	Code	(h) x (w) x (d) mm
Freestyle	PK161	1000 x 1000 x 500 mm
Graphic	PT161	1000 x 1000 x 500 mm
Carry Bag	AB112A	

V Counter Range



- MDF and PVC lectern
- Cable management system included

Model	Code	↕ (h) x (w) x (d) mm
Standard		
Ellipse	PK30SE	1020 x 950 x 520 mm
Keystone	PK30SK	1020 x 900 x 550 mm
Deluxe		
Ellipse	PK30DE	1020 x 950 x 520 mm
Keystone	PK30DK	1020 x 900 x 550 mm
Options		
Carry Case	AC347A	
LCD Support	Contact us	
iPad Holder ● ● ○	IPDM-W/S/B	305 x 230 mm
Fascia Kit	PK30FK	

Step 1: Choose your counter style



Standard Version:
With open back
(shown in Walnut)



Deluxe Version:
Internal shelf and lockable door
(shown in beech)

Step 2: Choose your tabletop shape

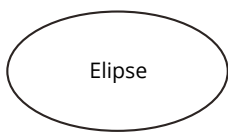

Ellipse

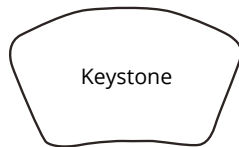

Keystone

Step 3: Choose the colour of the counter

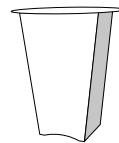

- PVC panels (sides) are available in two colours: ● ○

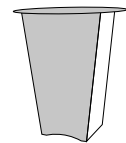

- Rigid MDF panels (tabletop, front and back) of the counter available in four colours: ● ● ○ ●

Step 4: Choose from three optional accessories



Optional LCD screen support available on request.

Deluxe counter shown with Keystone top, silver side panels and beech finish.

*LCD Screen not included



Optional flush mounted iPad holder available

Optional flush mounted iPad holder* available in three colours: white, silver and black.

Standard counter shown with Ellipse top, silver side panels and walnut finish.

*iPad not included



Optional Fascia Kit.

Standard counter shown with Keystone top, acrylic fascia panel, silver side panels and beech finish.



Basics Round Counter



- Cost effective Ø450mm round counter
- Grey corex fluted wrap
- Two carry bags included

Model	Code	↕ (h) x (ø) mm
Tabletop Beech/Black	PK923	926 x 450 mm
Tabletop Black/Beech	PK923-BLK	926 x 450 mm



Beech tabletop



Tabletops and bases are reversible



Carry bags

←
Cost effective counter solution

Basics Curved Counter



- Cost effective 'Double D' shape counter with grey plastic tambour wrap
- MDF tabletop and base available in beech/black and black/white
- Two carry bags included

Model	Code	↕ (h) x (w) x (d) mm
Tabletop Beech/Black	PK922	925 x 910 x 480 mm
Tabletop Black/Beech	PK922-BLK	925 x 910 x 480 mm



Large tabletop in black/white



Rear opening

↘
Ideal for lounges or receptions



Tornado



- Lightweight, weatherproof and durable curved outdoor or indoor counter with water drainage notches
- PVC graphic wrap can be directly printed
- Hollow base can be weighted for outdoor usage (sand or water)
- Support poles and header panel available as an optional extra (PK411)

Model	Code	(h) x (w) x (d) mm
Tornado	PK410	1040 x 850 x 500 mm
Header and Poles	PK411	250 x 600 x 20 mm
Tabletop and Base Bag	AB187	
Graphic Wrap Bag	AB187A	



Tabletop and base bag



Graphic wrap bag

Counta



- Indoor white PVC lightweight, portable demonstrator unit
- Includes header panel and shelf supporting poles
- Graphics can be applied as vinyl, or screen print directly onto the plastic base wrap

Model	Code	(h) x (w) x (d) mm
Counta	PC607	Graphic wrap: 2050 x 810 x 470 mm Header: 280 x 770 x 20 mm Assembled size: 2050 x 810 x 470 mm



Carry bag included

Promotional counter, ideal for retail use



Base can be weighted with water or sand for outdoor use



1. Formulate Drum
2. Embrace
3. Xclaim Cross

Backwalls

Our Backwall products include our Hop-up and Pop-up displays, they provide a quick and easy way to create stunning backdrops, exhibition stands and displays.

They are lightweight, compact and practical, with cleverly designed systems that set up in minutes. Graphics are easily attached to a Pop-up frame or left in place on a Hop-up.

Our range also allows for creative use of larger spaces, with linkable displays and large-scale graphics.



Choose a Backwall to create stunning visual impact.

Our Backwalls are large in stature but are also extremely portable and easy to use. Highly popular for events, commercial galleries, lounge road shows or just used as interior decoration, they are a creative backdrop for many situations.

Before Choosing Your Backwall, Ask Yourself:

1. What size is the area you need to cover?
2. What shape of Backwall is required?
3. What type of print media would you like to use?
4. How often will your display need to be refreshed or re-branded?
5. Does your Backwall display need to be reconfigurable?
6. How portable does your backwall display need to be?
7. Will lighting be required for your display?
8. How will your Backwall be transported?

// Our Range Of Display Backwalls



Formulate

A range of standard or custom structures manufactured from strong yet lightweight tubular aluminium, providing a simple and portable framework which can be dressed with a tensioned fabric graphic.



Hop-ups

A lightweight Hop-up frame system with locking arms. Fabric graphics fit smoothly across the framework attached in place once frame has been collapsed using hook and loop attachments. Can also be accessorised with overhead lights.

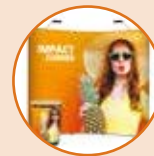

Pop-ups

Magnetic locking arms create an easy to use Pop-up frame structure. PVC graphics are held perfectly in position on the frame using graphic magnetic strips. Single or double-sided graphic option available and can be accessorised with lights and cases that convert to counters.



Embrace

Embrace is our Silicone Edge Graphic (SEG) Pop-up system with push-fit seamless fabric graphics, which hug a collapsible lightweight frame giving a sharp crisp image. Available in four sizes, Embrace allows you to erect a sophisticated display in minutes! Multiple frames can be joined together to create larger seamless.



Xclaim

This is a simple lightweight, collapsible frame with magnetic locking arms and push-fit fabric graphics. Coming in a variety of shapes and sizes, it is designed to be portable and durable and it can be set up and packed down quickly and easily.



Pegasus

This great range of adjustable tension backwalls have telescopic poles for adjusting the height and width, so they can fit all spaces and graphic sizes. Composed of lightweight aluminium tubes which the graphics slide onto.

Impact Pop-up Backwalls

2x Powerspot 950 lights included!

Impact Pop-up Bundle



- 3x1 to 3x5 straight or curved frame, single or double-sided
- Supplied with mag bars, hangers and kickers, and a roll of magnetic tape for single sided use
- Kit also includes a Zeus Case and hinged thermoformed tabletop in beech plus two Powerspot 950 halogen lights
- Self-locating 'smart' magnetic locking arms
- Optional extra rigidising bars placed below the hanger at the top of the graphics and at the bottom above the kicker, help graphics maintain shape (for straight frame structures only)

Bundle Kit Straight/Curved	Code	(h) x (w) x (d) mm
IMPACT 3X2 Curved	99-XX-110	2225 x 1930 x 485 mm
IMPACT 3X3 Curved	99-XX-071	2225 x 2540 x 685 mm
IMPACT 3X4 Curved	99-XX-070	2225 x 3070 x 960 mm
IMPACT 3X5 Curved	99-XX-111	2225 x 3430 x 1225 mm
IMPACT 3X1 Straight	99-XX-105	2225 x 1240 x 306 mm
IMPACT 3X2 Straight	99-XX-106	2225 x 1970 x 306 mm
IMPACT 3X3 Straight	99-XX-107	2225 x 2700 x 306 mm
IMPACT 3X4 Straight	99-XX-108	2225 x 3430 x 306 mm
IMPACT 3X5 Straight	99-XX-109	2225 x 4160 x 306 mm



Magnetic bars

Graphics are held firmly in place with magnetic fixings



Self-locating 'smart' magnetic locking arms

Zeus case and tabletop included!



Magnetic connectors

Printed case wrap and backwall graphics are optional extras



Impact Pop-up Bundle Kits



Curved or straight frame system structure (comes with drawstring bag)

+



Hangers, kickers and mag bars

+



2x Powerspot PS950 lights

+



1x roll of self-adhesive magnetic tape

+



Zeus case with thermoformed tabletop in beech

Quick+ Pop-up Backwalls



Quick+ Straight Pop-up



- Self-locating 'smart' magnetic locking arms
- Supplied with mag bars and adjustable clip-on graphic hanger fittings (roll of magnetic tape optional)
- PVC graphic attached with magnetic tape
- Available as straight or curved; single or double-sided
- Custom sizes available on request
- Padded carry bag with pockets

Model	Code	↕ (h) x (w) x (d) mm
3x1	WH221-S-CA	2225 x 1240 x 306 mm
3x2	WH222-S-CA	2225 x 1970 x 306 mm
3x3	WH223-S-CA	2225 x 2700 x 306 mm
3x4	WH224-S-CA	2225 x 3435 x 306 mm
3x5	WH225-S-CA	2225 x 4160 x 306 mm



Quick+ frame structure

+



Hangers, kickers and mag bars

+



Padded carry bag

Comes with adjustable feet for levelling on uneven floors



Self-attracting, easy to hook in magnetic top graphics



Easy to use magnetic rods

Bundled Kit

Quick+ straight Pop-up backwalls can also be supplied as a Bundle Kit which includes; Atlas case, tabletop and spotlights.



Quick+ Straight Pop-up Bundle



Model	Code	↕ (h) x (w) x (d) mm
3x2	99-XX-101Q	2225 x 1970 x 306 mm
3x3	99-XX-102Q	2225 x 2700 x 306 mm
3x4	99-XX-103Q	2225 x 3435 x 306 mm
3x5	99-XX-104Q	2225 x 4160 x 306 mm

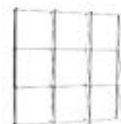

Quick+ frame structure

+



Hangers, kickers and mag bars



2x Powerspot PS1000 lights



1x roll of self-adhesive magnetic tape

+



Atlas case with folding thermoformed tabletop in beech



Rigidising Bars (WH260)

Quick+ Curved Pop-up



- Self-locating 'smart' magnetic locking arms
- Supplied with mag bars and adjustable clip-on graphic hanger fittings
- PVC graphic attached with magnetic tape
- Available as straight or curved; single or double-sided
- Custom sizes available on request
- Padded carry bag with pockets

Model	Code	↕ (h) x (w) x (d) mm
3x1	WH221-C-CA	2225 x 1240 x 306 mm
3x2	WH222-C-CA	2225 x 1930 x 485 mm
3x3	WH223-C-CA	2225 x 2540 x 685 mm
3x4	WH224-C-CA	2225 x 3070 x 960 mm
3x5	WH225-C-CA	2225 x 3430 x 1225 mm

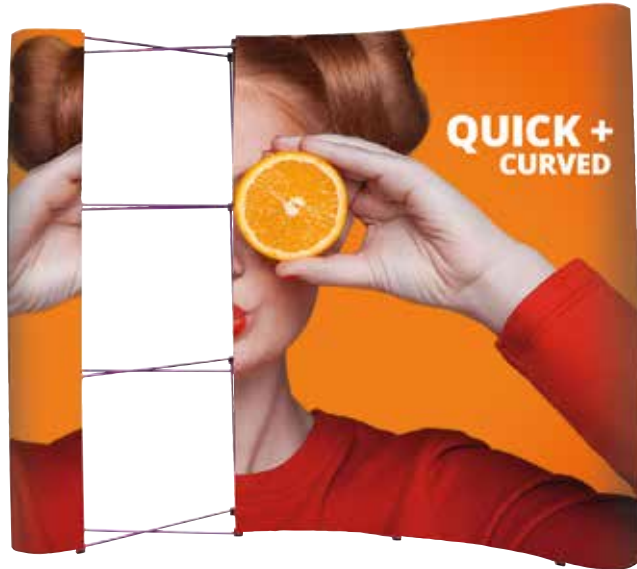

Easy to use flush fitting magnetic bars



Lights fit directly on top of nodes

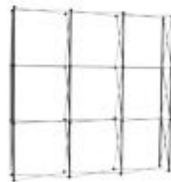

Quick+ frame structure



Hangers, kickers and mag bars



Padded carry bag

Bundled Kit

Quick+ curved Pop-up backwalls can also be supplied as a Bundle Kit which includes; Atlas case, tabletop and spotlights.

Lights fix directly on top of the frame nodes



Printed case wrap and backwall graphics are optional extras

Quick+ Curved Pop-up Bundle



Model	Code	↕ (h) x (w) x (d) mm
3x2	99-XX-016Q	2225 x 1930 x 485 mm
3x3	99-XX-017Q	2225 x 2540 x 685 mm
3x4	99-XX-020Q	2225 x 3070 x 960 mm
3x5	99-XX-021Q	2225 x 3430 x 1225 mm

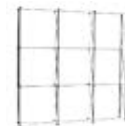

Quick+ frame structure



Hangers, kickers and mag bars



2x Powerspot PS1000 lights



1x roll of self-adhesive magnetic tape



Atlas case with folding thermoformed tabletop in beech



Available in
backlit version



Quick+ Tower



- Round Pop-up tower with self magnetic locking arms
- Supplied with mag bars, hangers and kickers (roll of magnetic tape optional)
- PVC graphic attached with magnetic tape
- Choice of heights up to four quads
- Illuminated version is available using optional lights (PS1200)

Model	Code	Size (h) x (ø) mm
3 Quad (h)	WH231A	2225 x 640 mm
4 Quad (h)	WH232A	2968 x 640 mm



Self-attracting, easy to hook in magnetic top graphics



Easy to use magnetic rods

Accessorise your Backwall

Increase the visual impact of your stands with our accessories



Pop-up Stabilising feet

ES505
Recommended for straight Pop-up systems where internal or external load-bearing shelving is used



Hop-up Stabilising feet

ES508
Recommended for all Hop-up systems



Fluorescent tube

PS1200
Light up your backwall with a linkable 20 watt fluorescent lighting and Linking cable (US601B)



LCD Screen bracket

PUSMK1/2/3
Add audio and visual to your stand using an LCD screen bracket, (supports screens up to 5kg)



Pop-up Shelving

ES514C-A - Curved
ES517-S - Straight



Pop-up Shelving Aperture Infill Panel

ES512 - Curved
ES513 - Straight



Internal Shelf

ES511X-C - Curved acrylic
ES511-S - Straight acrylic

Recommended with optional stabilising feet.



Pop-up Fabric

Hard wearing fabric panels, ideal for big-impact notice boards. Use plain or add graphics using hook fastenings. See page 102 for colour choices.

Fabric Hop-up Backwalls

Hop-up Impact Straight



- Lightweight fabric Hop-up system that is quick and easy to set up with yellow locking arms
- Fabric fits smoothly across the framework and stays in place once the frame has collapsed
- Graphic attached with hook and loop webbing
- Single-sided as standard (with or without ends) or double-sided as an option
- Adjustable feet
- Wheeled carry bag
- Custom sizes available on request

Model	Code	h x (w) x (d) mm
3X1	HUI3X1	2260 x 790 x 295 mm
3X2	HUI3X2	2260 x 1525 x 295 mm
3X3	HUI3X3	2260 x 2260 x 295 mm
3X4	HUI3X4	2260 x 2995 x 295 mm
3X5	HUI3X5	2260 x 3730 x 295 mm
Stabilising Feet	ES508	



Custom sizes also available



PS1060 Powerspot optional lighting (HUILF fitting kit required)



Easily transportable



Plastic connectors



Hook and loop fixings



Assembles in minutes!



Recommend with stabilising feet for uneven floors

Formulate Backwalls

Forget the structure – try these original and innovative shapes. Using Formulate for your stands, events and showrooms you can set your creativity free!

- Straight aluminium tube hardware diameter 32mm unless otherwise stated
- Fabric graphic with zip system
- Double-sided print
- Tool-free easy assembly with numbered frame parts
- Padded carry bags with internal pockets to store graphic and extra pockets for feet (only straight shape)



Formulate Straight



- Straight aluminium tube hardware diameter 30mm

Model	Code	↗ (h) x (w) x (d) mm
2400mm	FORM-STR-24	2380 x 2350 x 400 mm
3000mm	FORM-STR-30	2380 x 2950 x 400 mm
6000mm	FORM-STR-60	2380 x 5950 x 400 mm

Formulate Vertical Curve



Model	Code	↗ (h) x (w) x (d) mm
Vertical Curve	FMLT-USS-01	2280 x 3048 x 583 mm

Formulate Horizontal Curve



- Straight aluminium tube hardware diameter 30mm

Model	Code	↗ (h) x (w) x (d) mm
2400mm	FORM-CUR-24	2340 x 2350 x 500 mm
3000mm	FORM-CUR-30	2340 x 2950 x 500 mm
6000mm	FORM-CUR-60	2340 x 5950 x 600 mm



Easy matching system

Double-sided graphic

Can be accessorised with spot lights

Universal fitting kit required (US901-C)

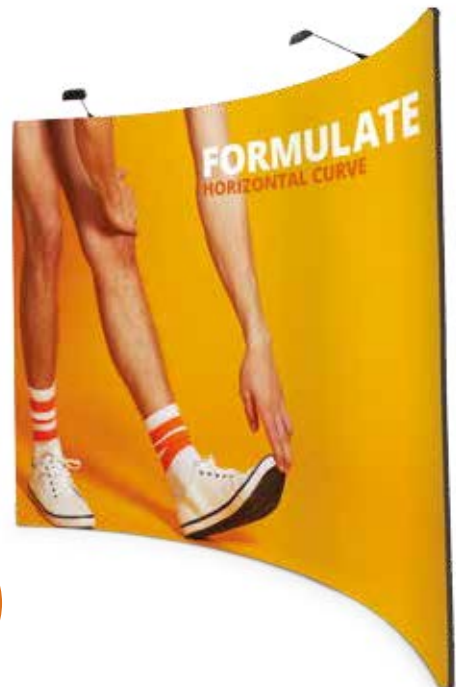

Tubes are connected by bungee cord

Formulate Drum



Model	Code	(h) x (w) x (d) mm
Drum	FMD5-3DC-01	2500 x 2200 x 400 mm



Allen key supplied



Make an impact in an instant in retail or hospitality environments

Formulate Accessories

Add even more to your Formulate display using screens, shelves or literature holders with our Universal Accessories.

A new accessory system has been designed to give you the freedom to add and change accessory items whenever you need to.

Step 1: Choose your clamp size



Universal Accessory Clamp
 FMLT158 - 30mm
 FMLT158-32 - 32mm

Make your Formulate display multi-functional with the Universal Accessory clamp

Step 2: Choose a support type



Literature-holder support
 FX839



iPad / screen support
 FX837



Shelf support
 FX838

Step 3: Choose your accessory



Literature holder
 AH5DLP - DL Format (110x220)
 AH5A5P - A5 Format
 AH5A4P - A4 Format



iPad holder
 IPAD-CHU-W - White 305 x 70 x 40 mm
 IPAD-CHU-S - Silver 305 x 70 x 40 mm
 IPAD-CHU-B - Black 305 x 70 x 40 mm



Shelves
 LN133-R - Circular 12 x 240 x 227 mm
 LN133-T - Triangular 12 x 254 x 246 mm
 LN133-S - Square 12 x 220 x 220 mm
 Four colours: ● ● ● ●

Embrace Backwalls

The ideal combination of a collapsible practical stand with push-fit seamless fabric graphic for a perfect finish.

Embrace



- Lightweight, simple assembly, anodised straight silver frame
- Complete with stabilising feet
- Push-fit fabric graphics create crisp straight edges
- Perimeter channel bars connect to frame and hold push-fit fabric graphics
- Can be used front only or with ends
- Additional bars can connect for double sided use
- Frames can be linked together to create larger walls

Model	Code	(h) x (w) x (d) mm
3x1	EMB-1X3-S	2255 x 790 x 328 mm
3x2	EMB-2X3-S	2255 x 1523 x 328 mm
3x3	EMB-3X3-S	2255 x 2239 x 328 mm
3x4	EMB-4X3-S	2255 x 2972 x 328 mm
Straight Connection Bracket	EMB-SL-CON	
L Link Connection Bracket	EMB-LL-CON	



Perfect fabric tension for crisp seamless graphics



Frames can be linked to create wider or taller displays

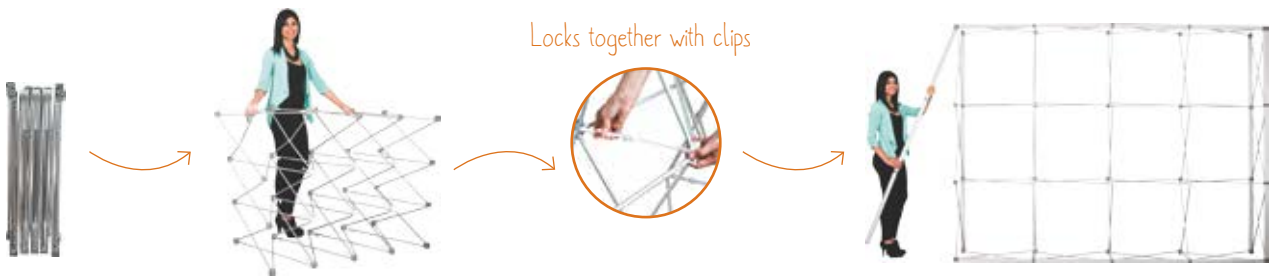

Locks together with clips

Easy push-fit fabric graphics go into channel

Channel bars for insertion of fabric graphics easily connect and slide onto collapsible frame

Easy snap arms



Xclaim



- Lightweight collapsible frame with magnetic locking arms and amazing push-fit fabric graphics
- Fabric fits smoothly across the framework and stays in place once the frame has collapsed
- Several variations can be created with only one frame

Model	Code	(h) x (w) x (d) mm
2x2	XCLM-2x2	1510 x 1510 x 315 mm
3x1	XCLM-3x1	2230 x 750 x 315 mm
3x2	XCLM-3x2	2230 x 1510 x 315 mm
3x3	XCLM-3x3	2230 x 2230 x 315 mm
3x4	XCLM-3x4	2230 x 2980 x 315 mm
3 Quad kits	XCLM-3QP	1600 x 2140 x 315 mm
6 Quad kits	XCLM-6QP	2090 x 3200 x 315 mm
10 Quad kits	XCLM-10QP	2620 x 4250 x 315 mm
Cross shape	XCLM-5QP	2130 x 2130 x 315 mm



Xclaim fabric panels are not only reconfigurable, but you can also vary their sizes for added versatility and style



Easy to use magnetic rods



Push-fit graphics



Attach multiple graphic panels to each push-fit

Many configurations are available



← → Ideal backdrop for photo shoots!



Pegasus



- Aluminium telescopic poles, adjustable up to 2500mm wide and high
- Vinyl or textile fabric graphics attached with pole pocket
- Lightweight and compact
- Carry bag with internal pockets

Model	Code	↗ (h) x (w) x (d) mm
Pegasus	UB165-S	1000-2515 (h) x 1429-2540 (w) x 442 (d) mm



Simple and quick to install



Twist to lock connectors



Telescopic poles

Available Summer 2017

Pegasus 3m



- Aluminium telescopic poles, adjustable up to 2500mm wide and high
- Vinyl or textile fabric graphics attached with pole pocket
- Lightweight and compact
- Carry bag with internal pockets

Model	Code	↗ (h) x (w) x (d) mm
Pegasus 3m	UB167	1835-2610 (h) x 1830-3200 (w) x 442 (d) mm



Simple and quick to install



Telescopic poles



← → Amazing compact 3m wide wall!

↻ Assemble without tools



1. Free-standing LED
2. Free-standing Vector

Modular Solutions

Exhibitions are one of the most effective showcases for your company to promote its products to your audience in the most direct way. The ability to make a great first impression is critical in order to fire the imagination of passers-by.

Our inspirational exhibition stand designs and reconfigurable solutions lead the market today.

Our modular exhibition stand systems are highly versatile. They use a range of materials to create different looks and textures, from a grand scale to simple designs.

The important thing is to make them impactful and cost-effective at the same time. You can choose from a range of our stand designs, or work with our 3D CAD Design Team to create a stand that fits your requirements perfectly.

Once created, our kits can be assembled quickly and easily using your own branding.

// A Solution For Every Need

Modular stand designs are flexible, re-configurable and re-usable. After initial purchase you can re-use the stand as many times as you wish.

They can be re-configured to freshen the appeal, selecting the components you need for the space, purpose and location, or adding new elements to it to fit a new space. Graphics can also be updated to give your existing stand a fresh new look each time if required.



Linear & Vector



Arena



Modular Panel Kits



Formulate

// Services Available

From an initial design briefing to production of inspiring concepts, to fully-specified stands, we can design, quote and build a display solution that meets your exact requirement as a full end-to-end service.



3D CAD Design

Our design team offers standard and bespoke display solutions. We have an extensive parts library to suit your specification and individual items, such as literature holders to complete the modular stand design.



Concepts & Quotation

Our experienced team will craft the solution to your exact requirements.



Pre-build

Manufacturing is completed in our own production facilities across Europe. Clients are invited to inspect pre-build stands before they are shipped.



Graphics

Our large-scale print facilities can provide all your graphic needs if required.



Installation & Dismantle

We can handle all your stand building requirements from design and build to transportation, installation and dismantling, as required.

Linear Range

The Linear range is ideally suited for applications such as image walls, stands and office furniture.

We recommend the use of rollable or rigid PVC to partially or completely cover the structure.

- Anodised aluminium profiles with four connectors
- Rollable PVC (550 micron) or rigid panel (5mm) covering
- Supplied with a roll of steel tape (optional magnetic tape, EM301 not included)
- Optional accessories available
- Manufactured to order

Two elegant designs



* Screen not included

Linear Executive Curve



Model	Code	(h) x (w) x (d) mm
2 LCD and 4 Shelf Supports*	LK030-001	2475 x 3000 x 500 mm
2 LCD and 4 Literature-holders*	LK030-002	2475 x 3000 x 500 mm
6 Literature holders	LK030-003	2475 x 3000 x 500 mm

Kit A - Curved Panel



Model	Code	(h) x (w) x (d) mm
Curved panel 1000mm	LK023-C	2000 x 1265 x 390 mm
Curved panel 2000mm	LK023-D	2000 x 2245 x 455 mm
Curved panel 3000mm	LK023-E	2000 x 3110 x 740 mm



Optional iPad support
See page 47



* iPad not included

Kit B - Straight Panel



Model	Code	(h) x (w) x (d) mm
Panel 1000 x 2000	LK021-A	1000 x 2550 x 400 mm
Panel 2000 x 500	LK021-B	2000 x 1050 x 400 mm
Panel 2000 x 1000	LK021-C	2000 x 1550 x 400 mm
Panel 2000 x 2000	LK021-D	2000 x 2550 x 400 mm
Panel 2000 x 3000	LK021-E	2000 x 3550 x 400 mm

LCD Panel Kit



Model	Code	(h) x (w) x (d) mm
LCD Panel 1000	LK025-C	2000 x 1250 x 400 mm
LCD Panel 2000	LK025-D	2000 x 2250 x 400 mm
LCD Panel 3000	LK025-E	2000 x 3250 x 400 mm



* Screen not included



Graphics attached with magnetic tape



75mm diameter posts

Vector Range

The Vector range is available in several models, it offers an optimal visual impact for original designs that adapt to every environment: showroom, points of sale, retails, shows, museums and many others.

Its textile display with silicone gasket makes it one of the simplest communication solutions on the market.

- Anodised aluminium profile
- Eight different thicknesses for backlit or non-illuminated use
- Self-supporting double-sided or wall-mounted
- Textile graphic with silicone edged gasket
- Optional accessories for 40 and 50mm profiles
- Custom sizes available
- Manufactured to order



Simple, quick assembly



Fabric graphic with silicone edging inserts into frame



Easy matching system



Side channel for stabilising feet



Side Foot SL1



Arched Foot SL2



Flat Foot LN115 (sold as singles)



Quarter Side Foot SFL1 (Allows panels to fit flush with wall)

Kit 1



Model	Code	↕ (h) x (w) x (d) mm
Linear Vector for fabric	VKF-H4-SL	2070 x 1000 x 450
Linear Vector for rigid substrate	VKR-H4-SL	2070 x 1000 x 450

Kit 2



Model	Code	↕ (h) x (w) x (d) mm
Linear Vector for fabric	VKF-2H4-2SL	2070 x 2000 x 450
Linear Vector for rigid substrate	VKR-2H4-2SL	2070 x 2000 x 450

Kit 3



Model	Code	↕ (h) x (w) x (d) mm
Linear Vector for fabric	VKF-3H4-2SL	2070 x 3000 x 450
Linear Vector for rigid substrate	VKR-3H4-2SL	2070 x 3000 x 450



Two pairs of optional flat feet shown (standard foot supplied SL2)



Vector Straight



Model	Code	(h) x (w) x (d) mm
Vector Straight 50mm	VKF-CUSTOM	Custom sizes available



LED Floodlight
LED-FLOOD-ARM-B



Side channel for
stabilising feet



Various styles of
stabilising feet available

Graphics pop with this
double-sided Vector LED



Available Summer 2017

NEW Vector LED



Model	Code	(h) x (w) x (d) mm
Vector LED 75mm	VLB75-CUSTOM	Custom size
Vector LED 100mm	VLB100-CUSTOM	Custom size
Vector LED 150mm	VLB150-CUSTOM	Custom size



360mm LED strip



Power socket



24V 75W transformer

LED Vector Profiles

The range of LED profiles comes in three sizes to provide a solution for every need and budget.



75mm LED

- Rectangular wall section
- Screw-in bracket assembly



100mm LED

- Double-sided self-supporting profile
- Screw-in bracket assembly



150mm LED

- Double-sided self-supporting profile
- Screw-in bracket assembly

Vector Lite Off the Peg Range

Vector Lite is a simple versatile solution for displays that need to fit in a variety of different sized spaces.

Larger than a Pop-up display without the layout of a full scale modular stand, Vector Lite is a fantastically adaptable display solution.

- Easy to assemble prefabricated panel kit system made from lightweight aluminium
- One cleverly designed channel supports a variety of media; foam board, PVC, or textile fabric
- Can be single or double-sided
- Create straight or curved display solutions
- Optional lighting and LCD Screen brackets are also available to maximise the functionality of your display

Vector Lite



Model	Code	(h) x (w) mm
On this page		
A - 950mm panel	VLF-H3-00	2000 x 950 mm
B - Slim silver foot	LN155	N/A
On opposite page		
C - 450mm panel	VLF-H1-00	2000 x 450 mm
D - 1450mm panel	VLF-H5-00	2000 x 1450 mm
E - Frame post	VLP-1000	N/A
F - Joining hook	VLF-03	N/A
G - Post Moulding	VLP-01	N/A



HOW TO BUILD WITH VECTOR LITE

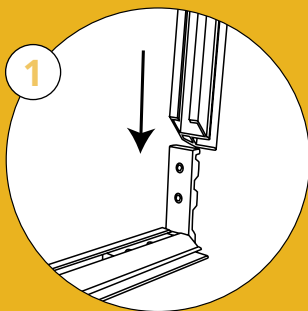

1 Push all of the frame Corner Cleats together and tighten using Allen keys.

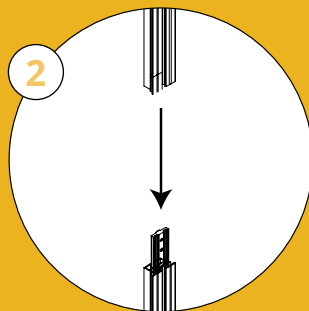

2 If you are joining frames together to make a larger frame, then push the Straight Joiners together and lock into place using grub screws.

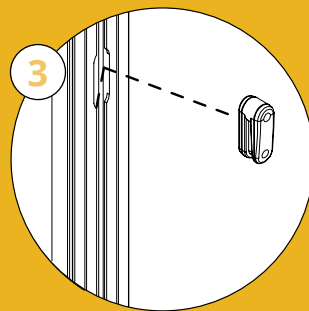

3 To join frames side-by-side, simply attach a Joining Hook into the grooved frame-edge and slot the frames together. These can be secured in place using grub screws.

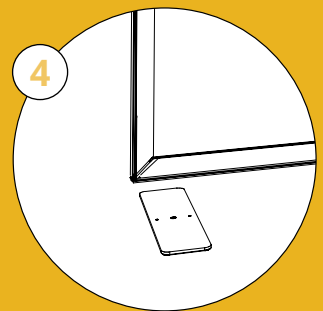

4 If you are just creating a wall with no corners, you will need to add feet in order to stabilise the display.



E Frame Post VLP-1000



F Joining Hook VLF-03



G Post Moulding VLP-01

Versatile solution for a variety of different display areas

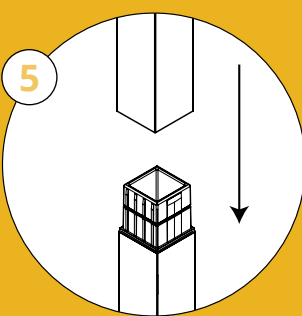

5 If you are adding a corner to your stand you will need a Frame Post. Slot the posts together until you achieve your ideal height (no tools required).

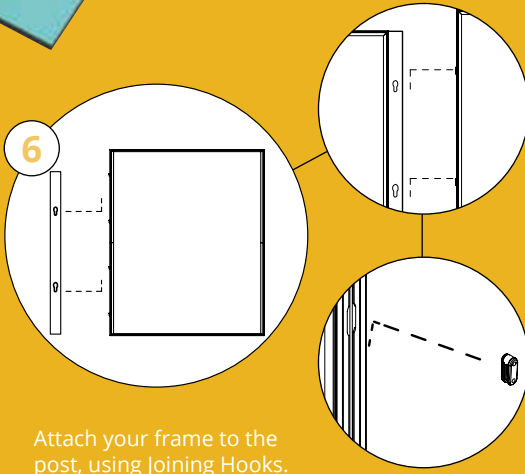

6 Attach your frame to the post, using Joining Hooks.

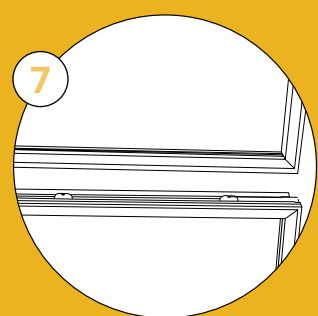

7 When stacking two frames*; slide in the Joining Brace, then tighten the grub screw with an Allen key (supplied). Align the top frame to fit the bottom frame.

* Stacking option is only available for 1000mm frames. Stack no more than two frames in total. Recommended maximum build-height is 2.5m, depending on configuration.

Formulate Range

Our Formulate range allows the creation of curves and original shapes. These are tubular aluminium structures with printed textile cladding.

The assembly of our Formulate structures is carried out with ease. The use of connectors with push buttons and the locating system on each element allows simple and tool-less assembly.

- Anodised aluminium tubular structure 30 or 50mm diameter
- Push Button Connectors
- Double-sided graphics
- Fabric graphic is pulled over frame and zipped closed
- Optional accessories with universal mounting kit



Easy-matching system



Fabric graphic zips over frame



Aluminium tubular structure

DS3 Designer 07



Model	Code	↗ (h) x (w) x (d) mm
Stand Designer 3m	FMLT-DS-30-07	2797 x 2499 x 495 mm



DS6 Designer 02



Model	Code	↗ (h) x (w) x (d) mm
Stand Designer 6m	FMLT-DS-60-02	2430 x 5790 x 620 mm



Ideal for reproducing curved and complex shapes



DS9 Designer 05



Model	Code	↗ (h) x (w) x (d) mm
Stand Designer 9m	FMLT-DS-90-05	2494 x 8627 x 472 mm



Extra large format visuals can be used to decorate or divide your exhibition space



2.7m Arch



Model	Code	↗ (h) x (w) x (d) mm
2.7m Arch	FMLT-ARC-01	2300 x 2700 x 1000 mm

Great for exhibition entrances!



6m Arch



Model	Code	↗ (h) x (w) x (d) mm
6m Arch	FMLT-ARC-02	3975 x 6000 x 1000 mm

Impressive 6m!



6m Triple Arch



Model	Code	↗ (h) x (w) x (d) mm
6m Triple Arch	FMLT-ARC-03	3975 x 6000 x 5000 mm

Fantastic for walkways



Meeting Pod



Model	Code	↗ (h) x (w) x (d) mm
Meeting Pod	FMLT-SC-01	2280-1219 x 3000 x 2495 mm

Ideal breakaway space





Circle Hanging Structure



Model	Code	↕ (h) x (dia) mm
Circle 1.5m diameter	FMHS-RIN-01	762 x 1524 mm
Circle 3m diameter	FMHS-RIN-03	914 x 3048 mm
Circle 4.6m diameter	FMHS-RIN-04	1524 x 4572 mm

*Please note: suspension cables not included



Metal hooks



Print on the inside and the outside



Eye Hanging Structure



Model	Code	↕ (h) x (w) x (d) mm
Eye 3m	FMHS-EYE-02	1219 x 3048 x 838mm
Eye 3.7m	FMHS-EYE-03	1524 x 3658 x 991mm



Tapered Circle Hanging Structure



Model	Code	↕ (h) x (dia) mm
Tapered Circle 3m	FMHS-TC-01	1067 x 3048-2438
Tapered Circle 4.6m	FMHS-TC-03	1219 x 4572-3962



Rectangle Hanging Structure



Model	Code	↕ (h) x (w) x (d) mm
Rectangle	FMHS-REC-01	1219 x 3658 x 2438 mm



Square Hanging Structure



Model	Code	↕ (h) x (w) x (d) mm
Square 2.4m	FMHS-SQU-01	1067 x 2438 x 2438 mm
Square 3m	FMHS-SQU-02	1219 x 3048 x 3048 mm

Arena Range

Our Arena system is an aluminium tubular stage structure, these particularly stable structures are both modular and scalable.

The different sections can be assembled and reused according to the needs of each project.

- Tubular aluminium frame 25mm diameter (approx)
- Straight sections available in nine different lengths
- Supports up to 100kgs over a 2m span
- Use in structures up to 6m long without a down section
- Graphic attached by bungee fixings
- Structure is assembled with bolt and wing-nut fixings

Versatile and scalable solution

Arena Kit 2



Add shelving, tablets or literature holders to increase functionality

Arena Kit 1



Sections assembled with wing-nuts and bolts

Can be used with traditional vinyl graphics or on-trend textile graphics



Design your own Arena structure



Model
Corner swivel plate
Code
UT-SP01



Model
45° triangular foot
Code
UT-AF250



Model
90° Angle Two-way corner
Code
UT-C21



Model
Three-way corner
Code
UT-C30



Model
Hanging plate 250mm
Code
UT-HP250



Model
Four-way T connector
Code
UT-C40



Model
Three-way T connector
Code
UT-C35



Model
Foot 250 mm
Code
UT-BS250



Model
Four-way corner
Code
UT-C41



Model
Five-way connector
Code
UT-C55



Model
Six-way connector
Code
UT-C65



Model
Curved section 1000mm
Code
UT-C1000

Model
Curved section 500mm
Code
UT-C500

Model
Section 250mm
Code
UT-S250

Model
Section 300mm
Code
UT-S300

Model
Section 500mm
Code
UT-S500

Model
Section 750mm
Code
UT-S750

Model
Section 1000mm
Code
UT-S1000

Model
Section 1250mm
Code
UT-S1250

Model
Section 1500mm
Code
UT-S1500

Model
Section 1750mm
Code
UT-S1750

Model
Section 2000mm
Code
UT-S2000

Baseline Panel Kits



- Three frame finishes: Baseline, Baseline Plus and Baseline aluminium
- Frames available in grey or black (Baseline and Baseline Plus only)
- Hinges allow kits to be configured in multiple ways
- Choice of loop nylon colours (see page 102)
- Made to order

Model	Code
-------	------

Size mm (approx) : 900 (h) x 600 (d) mm

6 Panel - Baseline	KK117
6 Panel - Baseline Plus	KKP117
6 Panel - Aluminium	KK117A
7 Panel - Baseline	KK114
7 Panel - Baseline Plus	KKP114
7 Panel - Aluminium	KK114A
8 Panel - Baseline	KK120
8 Panel - Baseline Plus	KKP120
8 Panel - Aluminium	KK120A
10 Panel - Baseline	KK124
10 Panel - Baseline Plus	KKP124



PS050 can be added



6 Panel Folding Kit

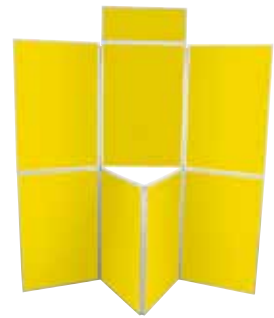

7 Panel Folding Kit

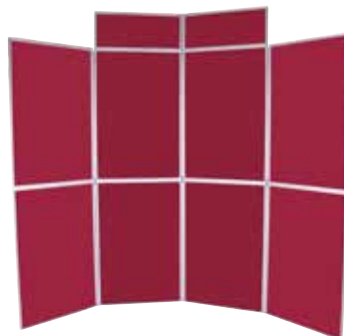

8 Panel Folding Kit

Model	Code
-------	------

Size in mm (approx) : 1000 (h) x 700 (d) mm

6 Panel - Baseline	KK317
6 Panel - Baseline Plus	KKP317
6 Panel - Aluminium	Call us
7 Panel - Baseline	KK314
7 Panel - Baseline Plus	KKP314
7 Panel - Aluminium	Call us
8 Panel - Baseline	KK320
8 Panel - Baseline Plus	KKP320
8 Panel - Aluminium	Call us
10 Panel - Baseline	KK222
10 Panel - Baseline Plus	KKP222

Panel and Pole Kits



- Four frame finishes: Baseline, Baseline Plus, Baseline aluminium, Phantom
- Stabilising feet included
- Frames available in grey or black
- Standard or Luxury loop nylon colours (see page 102)
- Made to order

Model	Code
Circular Feet (Recommended for additional stability)	LB913B-C (black) LB913S-C (grey)
Header Panel	Call us

Size in mm (approx): 900 (h) x 600 (d) mm

4 Panel - Baseline	KK104
4 Panel - Baseline Plus	KKP104-96
4 Panel - Aluminium	KK104A
6 Panel - Baseline	KK106
6 Panel - Baseline Plus	KKP106-96
6 Panel - Aluminium	KK106A
8 Panel - Baseline	KK108
8 Panel - Baseline Plus	KKP108-96
8 Panel - Aluminium	KK108A
10 Panel - Baseline	KK110
10 Panel - Baseline Plus	KKP110-96

Size in mm (approx): 1000 (h) x 700 (d) mm

6 Panel - Baseline Plus	KKP106-107
6 Panel - Phantom	KK132
8 Panel - Baseline Plus	KKP108-107
8 Panel - Phantom	KK134
10 Panel - Baseline Plus	KKP110-107
10 Panel - Phantom	KK136

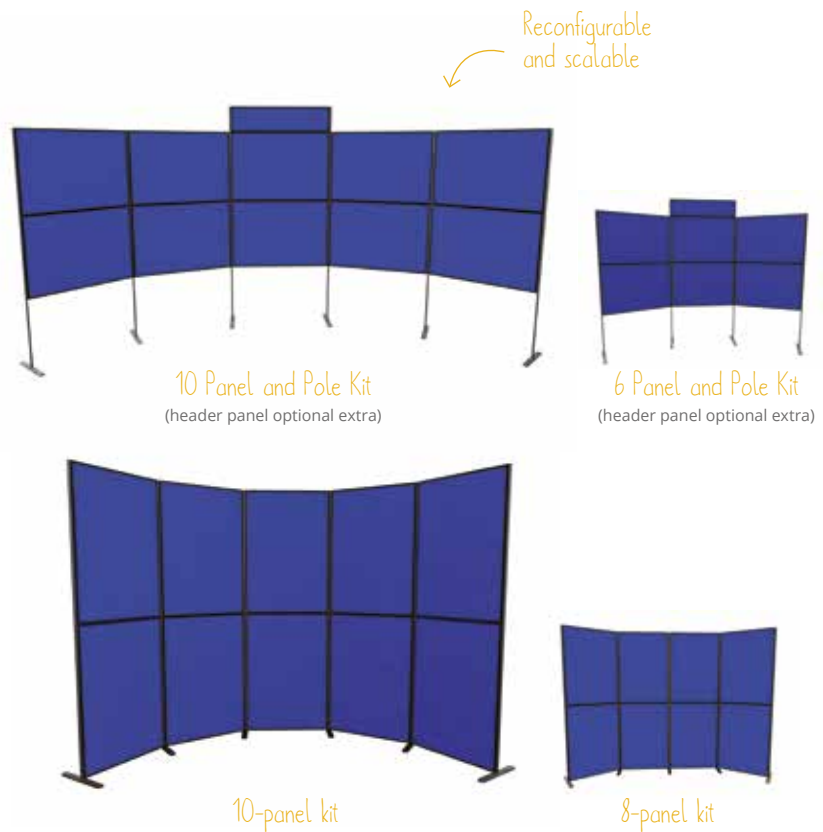

Jumbo Panel Kits



- Two frame finishes: Baseline Plus or Baseline aluminium
- Choice of loop nylon colour (see page 102)
- Made to order

Model	Code
-------	------

Size in mm (approx): 1800 (h) x 900 (d) mm

3 Panel - Baseline Plus	KKP350
3 Panel - Aluminium	KK350A
4 Panel - Baseline Plus	KKP351
4 Panel - Aluminium	KK351A

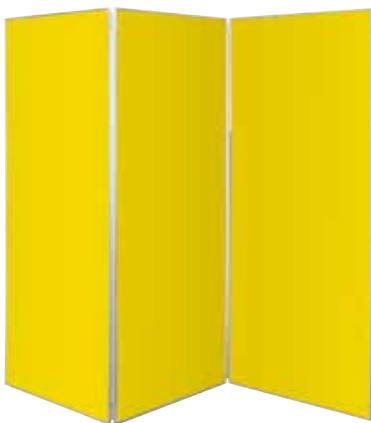

The Baseline Range has three possible frame finishes:

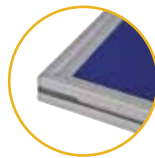

Baseline Frame (PVC)



Baseline Plus Frame (PVC)



Baseline Frame Aluminium

Phantom for Modular Stands:



Phantom Frame (PVC)

Phantom Frames are perfect for larger Modular Stands. With their invisible extrusion, frames seamlessly join to form great looking walls.

Frames are available in black or grey, and come in a range of standard sizes with custom sizes available on request.



Phantom Frame Modular Stand

Please note: our panels are guaranteed for use with hook and loop male and female tapes, these are provided by us and designed specifically for this use. We can not guarantee the panels if used with another hook and loop brand.

Tabletop Panel Kit



- Two frame finishes: Baseline and Baseline aluminium
- Baseline available in grey or black
- Whiteboard coating available on request
- Standard or Luxury loop nylon colours (see page 102)
- Made to order

Model	Code	↗ (h) x (d) mm
Junior Kit		
Baseline	KK102	Centre : 600 x 900 mm Sides: 600 x 450
Aluminium	KK102A	Header : 250 x 900
Senior Kit		
Baseline	KK103	Centre/Sides : 900 x 600
Aluminium	KK103A	Header : 250 x 900

Carry bag supplied



Junior Kit



Senior Kit

Wheeled Panel Kit



- One frame finish: Baseline Plus
- PVC frame
- Hinges for configuring the kit in multiple ways
- Choice of loop nylon colours (see page 102)
- Made to order

Model	Code
Size in mm (approx) : 1500/1800 (h) x 600 (d) mm	
5 Panel - Baseline Plus / 1500 mm	KKPW5-156
5 Panel - Baseline Plus / 1800 mm	KKPW5-186
6 Panel - Baseline Plus / 1500 mm	KKPW6-156
6 Panel - Baseline Plus / 1800 mm	KKPW6-186
7 Panel - Baseline Plus / 1500 mm	KKPW7-156
7 Panel - Baseline Plus / 1800 mm	KKPW7-186



7 Panel Kit



Ideal for arranging and dividing spaces

Gear Edge Range

Gear Edge Panel Kit



- Aluminium frame
- Available as frame only or supplied with fabric infills
- Hinges allow kit to be positioned in multiple ways
- Choice of loop nylon colours (see page 102)
- Made to order

Model	Code	↗ (h) x (d) mm
6 Panel - frame only	GEP6-96F0	2050 x 1500 mm
6 Panel - fabric covered	GEP6-96FC	2050 x 1500 mm
7 Panel - frame only	GEP7-96F0	2050 x 1500 mm
7 Panel - fabric covered	GEP7-96FC	2050 x 1500 mm
8 Panel - frame only	GEP8-96F0	2050 x 2100 mm
8 Panel - fabric covered	GEP8-96FC	2050 x 2100 mm



PS050 can be added



8 Panel Kit

Suitable for rigid graphics or loop nylon panels



7 Panel Kit



6 Panel Kit



1. Zed-Up Lite
2. Quantum

Literature Holders

Being able to display your literature in a way that encourages your visitor or customer to look and take it away is always the main challenge facing Marketers!

Our literature holders come in a variety of sizes and forms to give the greatest choice available. Literature completes your display and we provide a choice of stylish literature holders to suit any display situation – available in a range of materials and finishes including aluminium, polycarbonate, wood and injection moulded.

Zed-Up Lite



- Double-sided acrylic and anodised aluminium collapsible shelves
- Available in three sizes
- Complete with heavy duty hard case

Model	Code	↗ (h) x (w) x (d) mm
A5 (7 pockets)	AS318-002	1300 x 194 x 284 mm
A4 (6 pockets)	AS315-002	1460 x 256 x 370 mm
A3 (6 pockets)	AS319-002	1420 x 470 x 370 mm



Hard case included

Double-sided!
Brochures can
be stacked on
either side



Zed-Up



- Grey collapsible double-sided holder
- Six A4 pockets
- Foamed carry bag

Model	Code	↗ (h) x (w) x (d) mm
Zed-Up	WH412	1540 x 275 x 365 mm

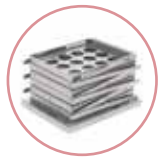

Ultra-compact

Can fold
with documents
in pockets

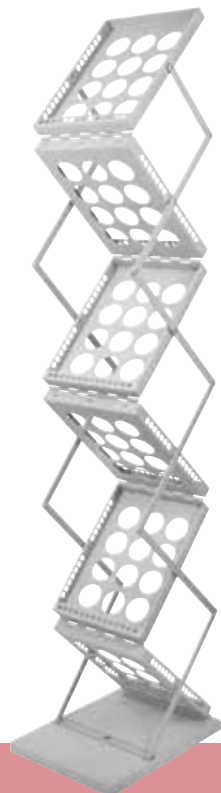

Cascade



- Lightweight polymer collapsible based literature holder
- Four A4 pockets
- One-step cantilever assembly action for easy collapsing
- Pockets that lock easily in an open or closed position

Model	Code	↗ (h) x (w) x (d) mm
Cascade	AS320	1480 x 265 x 310 mm



Complete with
carry bag



Portable,
lightweight and
easy to use



Quantum



- Black plastic collapsible double-sided shelves
- Five A4 pockets
- Foamed premium carry bag

Model	Code	(h) x (w) x (d) mm
Quantum	AS316-01	1320 x 285 x 380 mm



Ultra-compact

Double-sided



Carry bag included

Xanadu



- Four black fabric A4 pockets
- Three part construction

Model	Code	(h) x (w) x (d) mm
Xanadu	WH431	1365 x 280 x 380 mm

Quick setup

Linear Media Posts

 - Optional bag

- Portable and easy to assemble
- Anodised aluminium construction
- Three A4 adjustable angle literature holders included
- 450mm dia. steel dome base supplied as standard
- Graphic fixing kit included
- Optional ballast weight
- Additional Linear accessories are available

Model	Code	↕ (h) x (w) x (d) mm
Graphic and literature post	LK026-001	2060 x 523 x 450 mm
Ballast weight	LN900 (9kg)	
Steel literature holder (A4)	LN112-C	
Base bag	AB910	
Pole bag	AB293	

Injection Moulded System Literature Holders



- Smoked grey injection moulded literature holders
- Suitable for mounting onto Linear Vector, Formulate and Aero+ stands
- Can be wall mounted from the back
- Available in portrait for DL, A5 or A4

Model	Code	↕ (h) x (w) x (d) mm
A4	AH5A4P	330 x 254 x 55 mm
A5	AH5A5P	250 x 182 x 45 mm
DL	AH5DLP	250 x 132 x 45 mm



Literature holders angle to suit

All sizes can be mounted from either the left or right hand side of the literature holder or wall mounted from the back



1. Adjustable Tube
2. Atlas Case

Cases

We know that using lightweight luggage to transport your structures and visuals helps to make your work easier.

Our range of bags and cases are made of flexible and rigid materials adapted to your specific transport or storage needs.



Option to compartmentalise the inside



Interior compartments

Linear



- Large wheeled carry case for transporting Linear or Vector extrusion and kits
- Optional three tier inserts configurable to store different Linear extrusions
- Stackable for easy storage, complete with support straps for extra security

Model	Code	↕ (h) x (w) x (d) mm
Linear	AC506	1300 x 740 x 360 mm (External dimensions)
Linear (without compartments)	AC506-001	1300 x 740 x 360 mm (External dimensions)



Optional case linking kit



Case without graphic



Optional different shaped tabletops available for linked cases

Can hold 850mm roller banners



Zeus



- Wheeled lockable Pop-up case designed for safe transportation of Pop-up frame, fixings and graphics, manufactured from tough moulded polyethylene (MDPE).
- Will accept one 3x5 curved or straight Pop-up frame with graphic panels and mag bars with internal divider to protect graphics included
- Optional folding tabletop and graphic wrap to convert case into a counter
- Tabletop supplied in birch as standard, three extra colour options are available ●●○

Model	Code	↕ (h) x (w) x (d) mm
Zeus	AC338	970 x 610 x 395 mm (External dimensions)
Tabletop Birch ●	CO401-C	15 x 640 x 420 mm
Tabletop Black ●	CO401-B	15 x 640 x 420 mm
Tabletop Silver ●	CO401-S	15 x 640 x 420 mm
Tabletop White ○	CO401-W	15 x 640 x 420 mm



Case without graphic



Optional iPad* tabletop holder available:
CO401-IPB/S/W ●●○
*iPad not included

Atlas



- Wheeled lockable case manufactured from tough polyethylene (MDPE)
- Will accept roller banners up to 850mm or one 3x5 curved or straight Pop-up frame with graphic panels and mag bars
- Includes internal divider to protect graphics
- Graphic PVC or fabric wraps and hinged beech tabletop in different shapes available as optional extras to convert case into a counter
- Tabletop supplied in birch as standard but three extra colour options are available ●●○
- Link cases together to form unique stylish counter shapes using optional extra linking kit

Model	Code	↕ (h) x (w) x (d) mm
Atlas	AC372	1030 x 640 x 395 mm (External dimensions)
Case linking kit	FX632	
Tabletop Birch ●	CO372-C	15 x 660 x 437 mm
Tabletop Black ●	CO372	15 x 660 x 437 mm
Tabletop Silver ●	CO372	15 x 660 x 437 mm
Tabletop White ○	CO372	15 x 660 x 437 mm

Leonardo



- Wheeled lockable case manufactured from tough polyethylene (MDPE)
- Will accept one 3x3 curved or straight Pop-up frame with graphic panels and mag bars
- Includes internal divider to protect graphics
- Strong and durable, wheeled Pop-up case with wheels and handle for safe transportation of graphics
- Join two cases together to create an oval counter
- Optional fabric wrap and birch tabletop convert the case into an oval counter. Tabletop supplied in birch as standard but three extra colour options are available ●●○

Model	Code	↕ (h) x (w) x (d) mm
Leonardo	AC340	880 x 420 x 365 mm (External dimensions)
Tabletop Birch ●	CO402-C	15 x 450 x 420 mm
Tabletop Black ●	CO402	15 x 450 x 420 mm
Tabletop Silver ●	CO402	15 x 450 x 420 mm
Tabletop White ○	CO402	15 x 450 x 420 mm
Double Tabletop Birch ●	CO402-D	15 x 450 x 775 mm



Case without graphic



Joined cases

Join two cases to form a larger counter

Stealth Case



- Versatile and adaptable case to house components and graphics for the Stealth banner system (See Tension Banners section)
- Separate compartments securely hold two Stealth units one flexible joining panel and one graphic wrap
- Optional folding tabletop to create a counter
- Optional fabric wrap will personalise your counter

Model	Code	↕ (h) x (ø) mm
Case	N/A	N/A
Folding Tabletop for case (case not included)	CO332	565 x 475 x 15 mm
Case Graphic Wrap (case not included)	CO333Z	800 x 1600 mm



Separate compartments securely hold graphics

Graphic Case



- Wheeled lockable case manufactured from tough polyethylene (MDPE) with handles
- Holds up to eight graphic drops up to 900 or 1200mm wide, ideal for rolled banners and Pop-up graphics
- Optional folding tabletop and graphic wrap to convert case into a counter
- Tabletop supplied in birch as standard but three extra colour options are available ●●○

Model	Code	↕ (h) x (w) x (d) mm
Graphic Case 1100	AC331	1125 x 525 x 440 mm (External dimensions)
Tabletop Birch ●	CO332	25 x 560 x 470 mm
Tabletop Black ●	CO332	25 x 560 x 470 mm
Tabletop Silver ●	CO332	25 x 560 x 470 mm
Tabletop White ○	CO332	25 x 560 x 470 mm



Converts into a counter

Versatile Bags and Cases



Carry Bags



- Large range of bags to carry or store panel systems, banners, portable furniture and literature racks
- Standard sizes of bags or custom made to order
- Wheels and extra padding available as optional extras

Code	↕ (h) x (w) x (d) mm
Contact us	Standard or customised



Pop-up Frame Fabric Bag



- Protect your Pop-up frame by transporting or storing in a lightweight carry bag
- Takes up to 4x3 frame size
- Carry handle on top of bag

Code	↕ (h) x (ø) mm
AB105	770 - 1250 x 115 mm



Graphic Banner Tube



- Lightweight fabric bag with a choice of cardboard tube
- Shoulder strap for easy transportation
- Available with or without protective inner tube - please contact us

Code	↕ (h) x (w) x (d) mm
AB120M	880 (max) x 155 x 155 mm
AB120AM	1080 (max) x 155 x 155 mm
AB120CM	1280 (max) x 155 x 155 mm
AB120DM	1580 (max) x 155 x 155 mm

Available in custom sizes



Polypropylene Cases



- Cost-effective, strong polypropylene, standard or custom size cases.
- Can store or transport graphics, panels, Pop-ups, and literature stands
- Optional extras; wheels and extra padding are available on some cases

Code	↕ (h) x (w) x (d) mm
Contact us	Standard or customised



Padded Lighting Bag



- Foamed lightweight fabric bag
- Suitable for transporting two of the following lights; PS1000, PS950, PS1060S LED Floodlight, LED Spotlight, floodlight and exhibition
- Zipped with carry handles

Code	↕ (h) x (w) x (d) mm
AB101	570 x 180 x 120 mm



Mag Bar Bag



- Keeps your Pop-up mag bars safe and clean while in transit or after use in storage
- Fabric bag with hook and loop locking system
- Capacity to house up to 21 mag bars
- Complete with carry handle

Code	↕ (h) x (w) x (d) mm
AB104	735 x 110 x 70 mm



Available in two heights

Graphic Drum



- Choose from a range of sizes to enable you to transport graphics safely and securely
- Manufactured from tough yet lightweight polyethylene

Model	Code	↕ (h) x (ø) mm
850 mm (h)		
400 mm (ø)	AC305	850 x 400 mm
300 mm (ø)	AC306	850 x 300 mm
1020 mm (h)		
400 mm (ø)	AC365	1020 x 400 mm
300 mm (ø)	AC366	1020 x 300 mm



Ideal for protecting and extending the longevity of your banner graphics

Adjustable Graphics Tube



- Lightweight graphic drum manufactured from lightweight polypropylene with a twist and lock lid
- Telescopic body adjusts to fit a range of graphic sizes
- Shoulder strap for easy transportation

Code	↕ (h) x (ø) mm
GBT-001	770 - 1250 x 115 mm



Lighting

Make your displays come alive with great lighting that attracts attention. Focus attention on the elements you want to highlight.

Our full range of lighting includes halogen spotlights, neon lights and LED spotlights.

Fluorescent and Halogen Lighting



Powerspot 50



- 60 watt (240V) mains silver spotlight for use with panel systems
- 360° adjustable head
- Clamp fixing only (45mm post/beam)
- 3m power lead with UK or Euro plug (cross head screwdriver needed)

Model	Code
Powerspot 50	PS050



Powerspot 800



- 35 watt mains silver floodlight
- Curved arm with 180° adjustable head
- Integral bulldog clip specifically designed for 16mm diam banner stand poles
- Power lead with UK or Euro plug (cross head screwdriver needed)

Model	Code
Powerspot 800	PS800-101E



Powerspot 950



- Black 150 watt mains halogen floodlight
- Straight arm with 270° adjustable head
- Power lead with UK or Euro plug (cross head screwdriver needed)
- For use with Pop-up systems only

Model	Code
Powerspot 950	PS950-203E

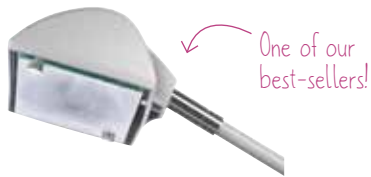

Powerspot 1000



- 120 watt mains halogen floodlight for use with Pop-up systems and Linear systems (fittings are an optional extra)
- Available in black or silver, lamp is protected by a glass barrier for safety 250mm straight arm with 360° adjustable head
- Power lead with UK or Euro plug (cross head screwdriver needed)
- Universal fitting kit included

Model	Code
Silver	PS1000-103E
Black	PS1000-203E
Carry Bag	AB101



Powerspot 1200



- 20 watt fluorescent light suitable for illuminating Pop-up end panels
- Simply clip on to attach, ultra slim design
- Up to six lights may be linked together using optional connecting lead US601B

Model	Code
Powerspot 1200	PS1200

Convert your UK plug into EU version

①



② Unscrew



③ Lift the back



④ Remove plug from casing



LED Lighting

LED lights use less energy, run cooler and last longer; reducing your electrical power requirements at exhibitions and shows.

- Bespoke design specifically for display and exhibition environments
- Greater efficiency means lower power consumption and higher light output
- Safety and CE approved



Powerspot 1060 LED

- 100 watt silver mains floodlight and a low consumption of 20 watts
- Straight arm with 360° adjustable head
- Universal fitting kit included
- Power lead with UK or Euro plug (cross head screwdriver needed)

Model	Code
Powerspot 1060 LED	PS1060S
Carry Bag	AB101



LED Spot Light

- 100 watt black LED light and a low consumption of 20 watts, specifically designed for banners
- Power lead with UK or Euro plug (cross head screwdriver needed)

Model	Code
LED Spot Light	LED-SPOT-ARM-B

Specifically designed for banners



Head rotates through 180°

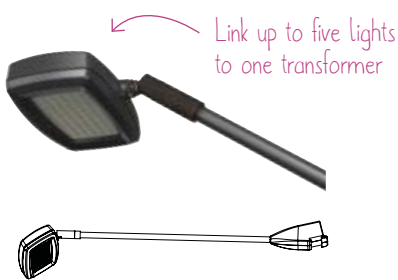

Link up to five lights to one transformer

LED Floodlight

Model	Code
Single Kit	LED-FLOOD-ARM-B
Double Kit	LED-FLOOD-ARM-BDLK
Transformer*	LED-ARM-TRANS

*Required when using -B code in isolation



Link up to five lights from one transformer!

LED Strip Light

Model	Code
Single Kit	LED-STRIP-ARM-B
Double Kit	LED-STRIP-ARM-BDLK
Transformer*	LED-ARM-TRANS

*Required when using -B code in isolation



LED Exhibition Light

Model	Code
Single Kit	LED-EXHIB-ARM-B
Double Kit	LED-EXHIB-ARM-BDLK
Transformer*	LED-ARM-TRANS

*Required when using -B code in isolation

Perfect to illuminate large exhibition spaces!

80 watt mains floodlight and a low consumption of 12 watt (1200lm). Single kit includes one spot (light only) and one 2.5m linking lead.

Double kit includes two spots, one cable, one transformer and one 2.5m linking lead. Link up to five lights from one transformer.

Fitting for Aero+, Linear and Vector included (Universal fitting for other systems an option). Power lead with UK or Euro plug (cross head screwdriver needed)

LED Lighting



LED Flood Lighting



- 85-265 voltage, 42 watt LED Flood light (equivalent to 400 watt halogen)
- Available in white and RGB
- Remote control only with RGB version
- Angles to 120°
- For indoor use only

Model	Code	↗ (h) x (w) x (d) mm
White	LED-FLOOD-40W	188 x 240 x 130 mm
RGB	LED-FLOOD-40W-RGB	188 x 240 x 130 mm



Mini LED Floodlight



- 10 watt LED flood light
- Available in white and RGB
- Remote control only with RGB version
- Angles to 120°
- For indoor use only

Model	Code	↗ (h) x (w) x (d) mm
White	LED-FLOOD-10W	86 x 114 x 101 mm
RGB	LED-FLOOD-10W-RGB	86 x 114 x 101 mm



Colour Blast Accent LED



- 85-265 voltage, 13 watt LED blast light
- Available in cool white or RGB spectrum flashing pattern
- Face plate is flush with base and angles to 60°
- For indoor use only

Model	Code	↗ (h) x (w) x (d) mm
White	LED-CW-BLAST	270 x 205 x 120 mm
RGB	LED-RGB-BLAST	270 x 205 x 120 mm

LED Lighting Kits



- Wide range of widths to suit your LED lighting requirements from 0.85m up to 2.5m
- Add up to four spare strips in series to further extend your lighting
- Choose from RGB or cool white
- Remote control only with RGB version

Model	Code
Flexi Kits	
Flexi Kit 0.85m RGB	LED-FK-85R
Flexi Kit 0.85m White	LED-FK-85W
Flexi Kit 1.5m RGB	LED-FK-150R
Flexi Kit 1.5m White	LED-FK-150W
Spare Strips	
0.85m RGB	LED-SS-85R
0.85m White	LED-SS-85W
1.5m RGB	LED-SS-150R
1.5m White	LED-SS-150W
2.5m RGB	LED-SS-250R
2.5m White	LED-SS-250W

Flexi Kits



Spare Strips



Lighting Fixings



Vector Fitting



Model	Code
Vector Fitting	VLF



Universal Fixing Kit



- Included with PS1000/PS1060
- Includes: Clamp ring, Pop-up plate, Universal plate, Screwdriver
- Enables lights to be fitted to banners, Pop-ups, modular panel systems and Arena 4 Gantry

Model	Code
Universal Fixing Kit	US901-C



Linear Fitting



Model	Code
Linear Fitting	US-LINEAR



Hop-Up Fitting



Model	Code
Hop-up Fitting	HUILF



Compatible with...

Products	Panel Systems	Roller Banners	Impact	Quick +	Hop-up / Xclaim	Embrace	Formulate	Linear	Vector	Arena
PS050	●									
PS800		●								
PS950			●	●*		●				
PS1000			●	●	●	●	●	●	●	●
PS1200			●**	●**						
PS 1060 LED			●	●	●	●	●	●	●	●
LED Spot		●								
LED Flood	●	●***	●	●	●	●	●	●	●	●
LED Strip	●	●***	●	●	●	●	●	●	●	●
LED Exhibition								●	●	

● Linear Fitting not supplied

● Vector Fitting not supplied

● Hop-Up Fitting HUILF not supplied

● Fitting integrated with spot

● Universal Fixing Kit US901-C not supplied







* Except for Pop-up Tower
** Only for Pop-up
*** Only for Aero+



Media Specifications and Colours

The colours shown on this page are given as an indication only. In order to find the desired colour more easily, colour charts are available on request.

Standard Loop Nylon

				
Ba navy	Quince green	Bottle green	Emerald green	New silver grey
				
Dove	Black	Cherry red	Burgundy	Primrose
				
Wedge-wood	Royal blue	Regal blue		







Suitable for Evolution fabric panels and panel kits. Not suitable for Physique.

Luxury Foam Backed Nylon

				
Ink navy	Emerald green	Quince green	Bottle green	Medici
				
New grey	Black	Gunmetal	Plasma red	Saffron
				
Steel blue	Pacific	Dark wine		





Suitable for Physique fabric panels and panel kits.

Smooth (formerly Prelude)

				
Platinum	Eclipse	Storm	Electric blue	Aegean
				
Royal	Flame			

Suitable for Phantom, Evo and Physique.

Colours for Shelves and Counters

			
Beech	Black	Silver	White



Index

A

Acrylic Poster Holder.....	43
Adjustable Fixing Cable.....	43
Adjustable Graphics Tube.....	96
Aero+.....	14
Aluminium Rail Screw Fixing.....	43
Arena Kit 1.....	85
Arena Kit 2.....	85
Arena Range.....	85
A-sign Board.....	33
Atlas.....	94
Avant.....	7

B

Backwall Accessories.....	68
Backwalls.....	63
Barracuda.....	5
Baseline Panel Kits.....	86
Bases for Zoom flags.....	25
Basics Curved Counter.....	61
Basics Leader.....	35
Basics Round Counter.....	61
Blade+.....	8
Blizzard.....	31
Breeze.....	9

C

Carry Bags.....	96
Cases.....	93
Circular Parasol.....	37
Colour Blast Accent LED.....	100
Comet.....	59
Compact Variable Cable Fixing.....	43
Compact Variable Wall Plate.....	43
Counta.....	62
Counters.....	51
Curved Workstation.....	58

D

Delta+.....	8
Deluxe Café.....	35
Design iPad Holder 360° Mount.....	47
Double D.....	59
Double Panel Support.....	43
Double-sided Banners.....	12
Dragonfly2.....	12

E

Eclipse.....	58
Economy Café.....	35
Edge2.....	12
Electric Pump.....	38
Element.....	13
Embrace.....	72
Embrace Backwalls.....	72
Exc caliber2.....	12

F

Fabric Hop-up Backwalls.....	69
Firefly.....	10
Flags.....	21
Floor to Ceiling Fixing Cable.....	43
Fluorescent & Halogen Lighting.....	98
Folding Table.....	48
Form. Circle Hanging Structure.....	84
Form. Large Rectangle Counter.....	57
Form. Rectangle Hanging Structure.....	84
Form. Square Hanging Structure.....	84
Form. Tapered Circle Hanging Struc.....	84
Formulate 2.7m Arch.....	83
Formulate 6m Arch.....	83
Formulate 6m Triple Arch.....	83
Formulate Accessories.....	71
Formulate Backwalls.....	70

Formulate Counters.....	57
Formulate Curl.....	17
Formulate Drum.....	71
Formulate DS3 Designer 07.....	82
Formulate DS6 Designer 02.....	82
Formulate DS9 Designer 05.....	82
Formulate Eye Hanging Structure.....	84
Formulate Horizontal Curve.....	70
Formulate Lite.....	23
Formulate Meeting Pod.....	83
Formulate Monolith.....	17
Formulate Oval Counter.....	57
Formulate Range.....	82
Formulate Rectangle Counter.....	57
Formulate Slant.....	17
Formulate Snake.....	17
Formulate Straight.....	70
Formulate Tension Banners.....	17
Formulate Vertical Curve.....	70
Free-standing iPad Holder.....	46
Free-standing Tablet Holder.....	46

G

Gear Edge Counter.....	56
Gear Edge Display Counter.....	56
Gear Edge Panel Kit.....	88
Gear Edge Range.....	88
Giant Mosquito.....	11
Graphic Banner Tube.....	96
Graphic Case.....	95
Graphic Drum.....	96
Grasshopper.....	11

H

Hand Pump.....	38
Hop-up Counta.....	53
Hop-up Fitting.....	101
Hop-up Impact Straight.....	69
Horizon.....	31

I

Imagine+.....	5
Impact Pop-up Backwalls.....	65
Impact Pop-up Bundle.....	65
Impact Pop-up Bundle Kits.....	65
Inflatable Column.....	38
Inflatable Tent.....	38
Inj. Moulded System Lit. Holders.....	92
Insert for Screw Fixing.....	43
Insert Rail Fixing.....	43

J

Jumbo Panel Kits.....	87
-----------------------	----

L

LCD Panel Kit.....	77
Lecturn Linear Column.....	56
LED Exhibition Light.....	99
LED Floodlight.....	99
LED Flood Lighting.....	100
LED Lighting.....	99, 100
LED Lighting Kits.....	100
LED Spot Light.....	99
LED Strip Light.....	99
LED Trappa Frame.....	45
LED Vector Profiles.....	79
Leonardo.....	95
Liberty.....	9
Liberty Mini.....	9
Lighting.....	97
Lighting Fixings.....	101
Linear.....	94
Linear Column.....	56
Linear Curved Counter.....	55
Linear Executive Curve.....	77

Linear Executive Wave.....	77
Linear Fitting.....	101
Linear Kit A - Curved Panel.....	77
Linear Kit B - Straight Panel.....	77
Linear Lite Counter.....	55
Linear Media Posts.....	92
Linear Range.....	77
Linear Straight Counter.....	55
Literature Holders.....	89
Luna.....	58

M

Mag Bar Bag.....	96
Mayfly.....	10
Measuring Light.....	99
Media Specifications and Colours.....	102
Mercury.....	59
Merlin.....	6
Mini LED Floodlight.....	100
Mistral.....	27
Modular Solutions.....	75
Monsoon.....	34
Mosquito.....	11
Multi-funct. LCD/LED/Plasma Stand.....	48

O

Orient+.....	7
Original+.....	6
Outdoor.....	29

P

Padded Lighting Bag.....	96
Panel and Pole Kits.....	87
Panel Supports.....	43
Pegasus.....	74
Pegasus 3m.....	74
Phantom.....	87
Physique Flag Kit.....	59
Physique Header Kit.....	59
Physique Range.....	58
Pioneer.....	13
Polypropylene Cases.....	96
Pop-up Counta.....	53
Pop-up Frame Fabric Bag.....	96
POS Signage.....	39
Powerspot 50.....	98
Powerspot 800.....	98
Powerspot 950.....	98
Powerspot 1000.....	98
Powerspot 1060 LED.....	99
Powerspot 1200.....	98
Print & Finishing.....	28
Prism.....	9

Q

Quantum.....	91
Quick+ Curved Pop-up.....	67
Quick+ Curved Pop-up Bundle.....	67
Quick+ Pop-up Backwalls.....	66
Quick+ Straight Pop-up.....	66
Quick+ Straight Pop-up Bundle.....	66
Quick+ Tower.....	68

R

Reflecta Lite LED.....	49
Reflecta Trappa.....	49
Revolution.....	13
Roller Banners.....	3
Rotating Edge Stand-offs.....	43

S

SEG Fabric Counter.....	53
Sentry.....	45
Shield.....	33
Shimmer.....	27

Sign Board Lite.....	33
Spiral Display Tower.....	50
Spiral Plinth.....	50
Square Parasol.....	37
Stand-offs.....	42
Stealth.....	18
Stealth Accessories.....	19
Stealth Case.....	95
Stellar.....	13
Storm Hydro2.....	31
Stowaway.....	32
Strata Lite Stand-offs.....	42
Strata System.....	42
Street Flag.....	26

T

Tabletop iPad Holder.....	59
Tabletop Panel Kit.....	88
Telescopic iPad Holder.....	47
Tension Banners.....	15
The Baseline Range.....	87
Thunder2.....	32
Tornado.....	62
Trappa Frame.....	45
Trappa Rail.....	41
Twista Lite.....	41

U

Universal Fixing Kit.....	101
Uno.....	20

V

V Counter Range.....	60
Vector Counter.....	54
Vector Curved Counter.....	54
Vector Fitting.....	101
Vector Kit 1.....	78
Vector Kit 2.....	78
Vector Kit 3.....	78
Vector LED.....	79
Vector LED 30mm.....	44
Vector Lite.....	80
Vector Quick Fix.....	44
Vector Range.....	78
Vector Straight.....	79
Versatile bags and cases.....	96
Vision Banners.....	13
Vortex.....	20

W

Wall Monsoon.....	34
Wasp.....	10
Wedge.....	20
Wheeled Panel Kit.....	88
Whirlwind.....	32
Wind Dancer 4m / 5m.....	27

X

Xanadu.....	91
Xclaim.....	73

Z

Zed-Up.....	90
Zed-Up Lite.....	90
Zeus.....	94
Zoom Aqua.....	26
Zoom+ Crest / Feather / Quill Flags.....	24
Zoom Double Tent Kit.....	36
Zoom+ Edge Flags.....	24
Zoom+ Flags.....	24
Zoom Tent.....	36
Zoom Tent Accessories.....	36
Zoom Tent Kit.....	36

Our Product Range

We are dedicated to delivering the widest choice of products from cost effective, to premium quality. We promise to continuously search for new and pioneering ideas bringing innovation and excitement to our complete range of portable display products. Our products cover a broad range of needs from simple cost effective display solutions to more comprehensive and specialist displays for both one off and semi-permanent use.

Design and Patent

Some of the products in our catalogue carry a worldwide Patent, some carry a Design Patent. All of our unique products are designed in the UK / USA and designs are registered. Due to variations in graphic substrates, graphic thicknesses stated are provided as a guide only. Always check the suitability of your substrate on the display unit before application.



lavenderconsulting

creativesolutions ● print ▲ design ■ display ● promotional media

Lavender Consulting U.K. Limited, 111 Wood Close, Windsor, Berkshire SL4 3LB
📞 01753 624200 ✉ sales@lavenderconsulting.uk.com 🌐 www.lavenderconsulting.uk.com